

# QM600HD-M

HIGH POWER SWITCHING USE  
NON-INSULATED TYPE

QM600HD-M



- **IC** Collector current ..... **600A**
- **VCEX** Collector-emitter voltage ..... **350V**
- **hFE** DC current gain ..... **500**
- **Non-Insulated Type**

## APPLICATION

Robotics, Forklifts, Welders

## OUTLINE DRAWING & CIRCUIT DIAGRAM

Dimensions in mm

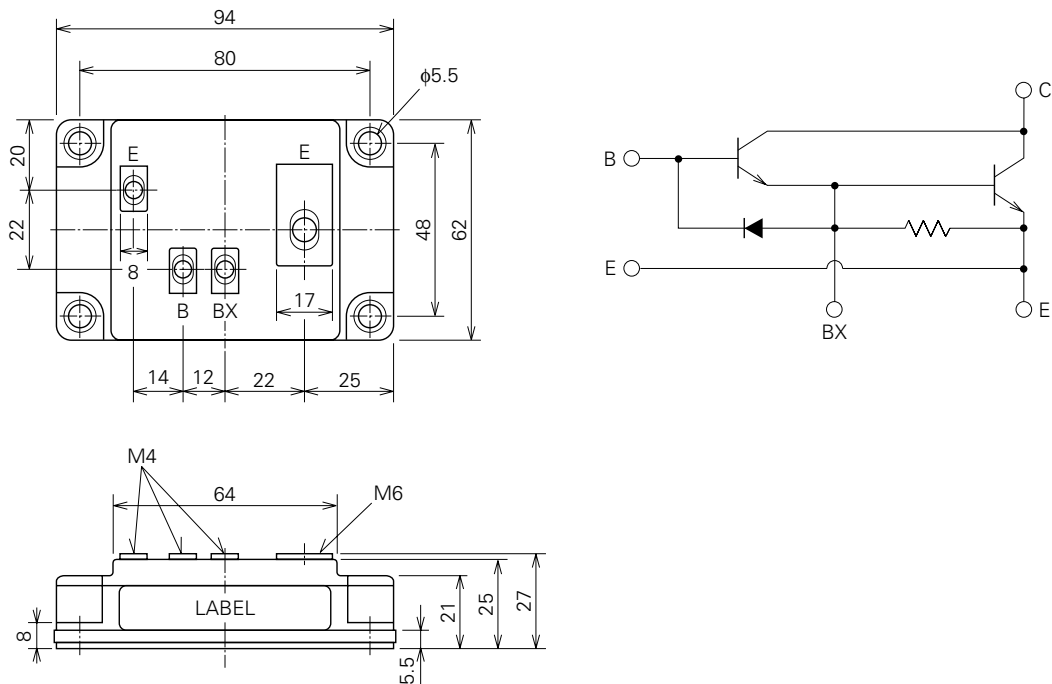

**QM600HD-M**

**HIGH POWER SWITCHING USE  
NON-INSULATED TYPE**

**ABSOLUTE MAXIMUM RATINGS** (T<sub>j</sub>=25°C, unless otherwise noted)

Symbol	Parameter	Conditions	Ratings	Unit
V <sub>CEX (SUS)</sub>	Collector-emitter voltage	I <sub>C</sub> =1A, V <sub>EB</sub> =2V	350	V
V <sub>CEX</sub>	Collector-emitter voltage	V <sub>EB</sub> =2V	350	V
V <sub>CBO</sub>	Collector-base voltage	Emitter open	400	V
V <sub>EBO</sub>	Emitter-base voltage	Collector open	10	V
I <sub>C</sub>	Collector current	DC	600	A
-I <sub>C</sub>	Collector reverse current	DC (forward diode current)	—	A
P <sub>C</sub>	Collector dissipation	T <sub>C</sub> =25°C	2080	W
I <sub>B</sub>	Base current	DC	15	A
-I <sub>CSM</sub>	Surge collector reverse current (forward diode current)	Peak value of one cycle of 60Hz (half wave)	—	A
T <sub>j</sub>	Junction temperature		-40~+150	°C
T <sub>stg</sub>	Storage temperature		-40~+125	°C
V <sub>iso</sub>	Isolation voltage	Charged part to case, AC for 1 minute	—	V
—	Mounting torque	Main terminal screw M6	1.96~2.94	N·m
			20~30	kg·cm
		Mounting screw M5	1.47~1.96	N·m
			15~20	kg·cm
		B(E) terminal screw M4	0.98~1.47	N·m
			10~15	kg·cm
—	Weight	BX terminal screw M4	0.98~1.47	N·m
			10~15	kg·cm
—	Weight	Typical value	420	g

**ELECTRICAL CHARACTERISTICS** (T<sub>j</sub>=25°C, unless otherwise noted)

Symbol	Parameter	Test conditions	Limits			Unit
			Min.	Typ.	Max.	
I <sub>C</sub> EX	Collector cutoff current	V <sub>CE</sub> =350V, V <sub>EB</sub> =2V	—	—	2.0	mA
I <sub>C</sub> BO	Collector cutoff current	V <sub>CB</sub> =400V, Emitter open	—	—	2.0	mA
I <sub>E</sub> BO	Emitter cutoff current	V <sub>EB</sub> =10V	—	—	800	mA
V <sub>CE (sat)</sub>	Collector-emitter saturation voltage	I <sub>C</sub> =600A, I <sub>B</sub> =1.2A	—	—	2.0	V
V <sub>BE (sat)</sub>	Base-emitter saturation voltage		—	—	2.5	V
-V <sub>CEO</sub>	Collector-emitter reverse voltage	-I <sub>C</sub> =600A (diode forward voltage)	—	—	—	V
h <sub>FE</sub>	DC current gain	I <sub>C</sub> =600A, V <sub>CE</sub> =2V	500	—	—	—
t <sub>on</sub>	Switching time	V <sub>CC</sub> =200V, I <sub>C</sub> =600A, I <sub>B1</sub> =2A, -I <sub>B2</sub> =4A	—	—	3.0	μs
t <sub>s</sub>			—	—	15	μs
t <sub>f</sub>			—	—	3.0	μs
R <sub>th (j-c) Q</sub>			Thermal resistance (junction to case)	Transistor part	—	—
R <sub>th (j-c) R</sub>	Diode part	—		—	—	°C/W
R <sub>th (c-f)</sub>	Contact thermal resistance (case to fin)	Conductive grease applied	—	—	0.05	°C/W

# QM600HD-M

HIGH POWER SWITCHING USE  
NON-INSULATED TYPE

## PERFORMANCE CURVES

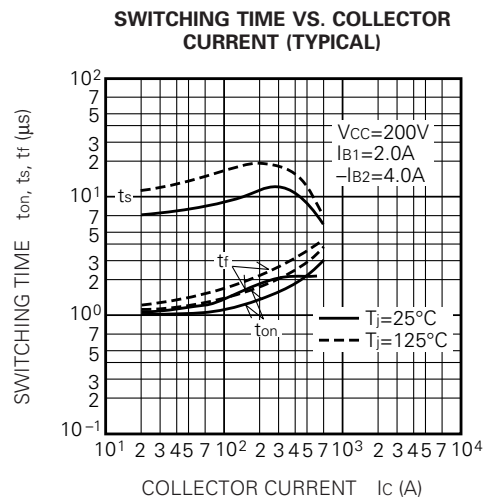
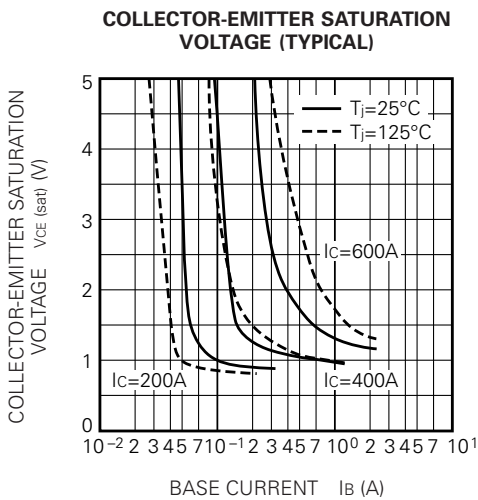
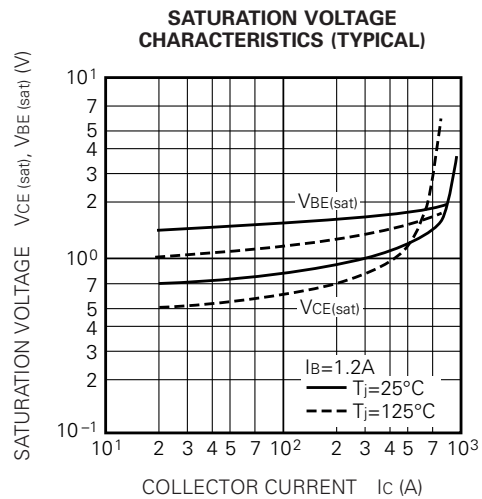
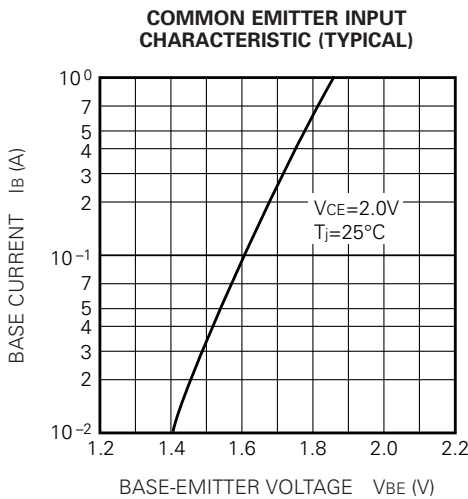
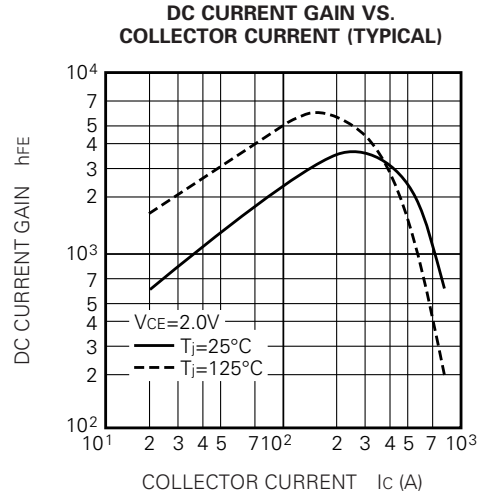
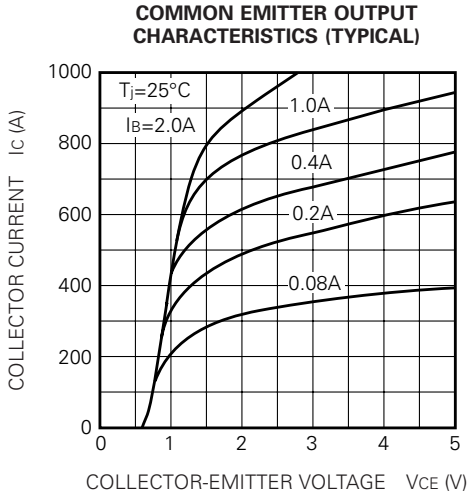

QM600HD-M

HIGH POWER SWITCHING USE  
NON-INSULATED TYPE

SWITCHING TIME VS. BASE CURRENT (TYPICAL)

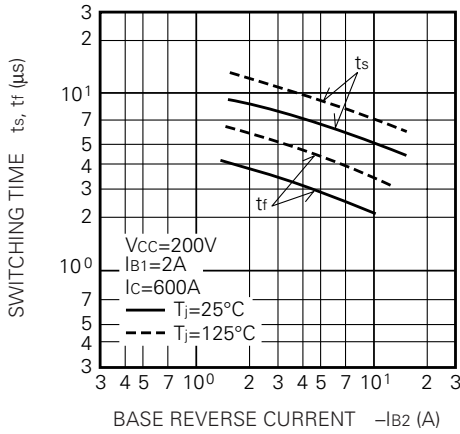

REVERSE BIAS SAFE OPERATING AREA

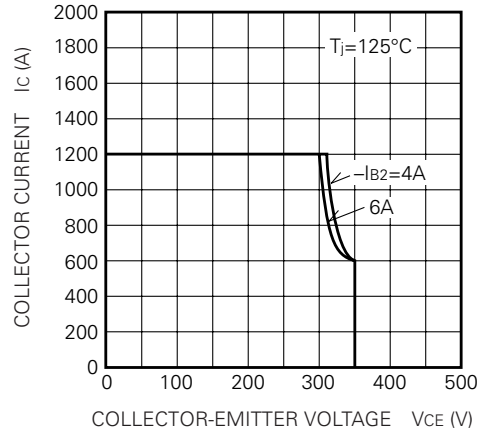

FORWARD BIAS SAFE OPERATING AREA

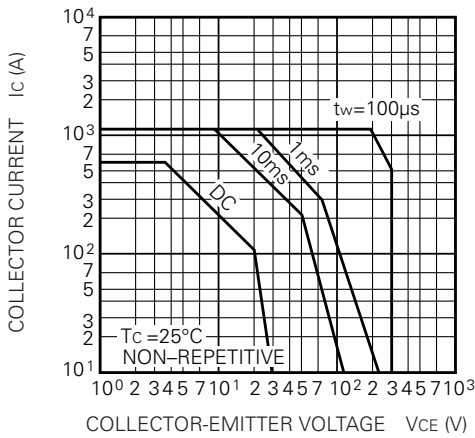

DERATING FACTOR OF F. B. S. O. A.

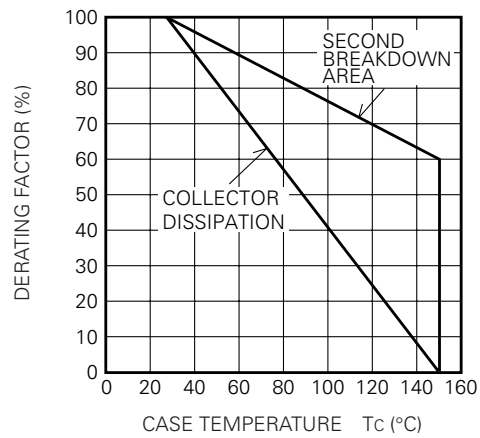

TRANSIENT THERMAL IMPEDANCE CHARACTERISTIC (TRANSISTOR)

