

Amplifier Transistors

NPN Silicon

BC237,A,B,C
BC238B,C
BC239,C

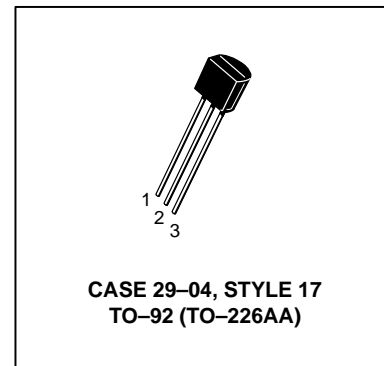
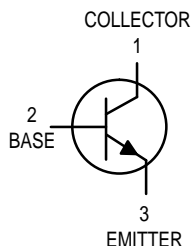

MAXIMUM RATINGS

Rating	Symbol	BC 237	BC 238	BC 239	Unit
Collector–Emitter Voltage	V_{CEO}	45	25	25	Vdc
Collector–Emitter Voltage	V_{CES}	50	30	30	Vdc
Emitter–Base Voltage	V_{EBO}	6.0	5.0	5.0	Vdc
Collector Current — Continuous	I_C	100			mAdc
Total Device Dissipation @ $T_A = 25^\circ\text{C}$ Derate above 25°C	P_D	350			mW
		2.8			mW/ $^\circ\text{C}$
Total Device Dissipation @ $T_C = 25^\circ\text{C}$ Derate above 25°C	P_D	1.0			Watts
		8.0			mW/ $^\circ\text{C}$
Operating and Storage Junction Temperature Range	T_J, T_{stg}	–55 to +150			$^\circ\text{C}$

THERMAL CHARACTERISTICS

Characteristic	Symbol	Max	Unit
Thermal Resistance, Junction to Ambient	$R_{\theta JA}$	357	$^\circ\text{C}/\text{W}$
Thermal Resistance, Junction to Case	$R_{\theta JC}$	125	$^\circ\text{C}/\text{W}$

ELECTRICAL CHARACTERISTICS ($T_A = 25^\circ\text{C}$ unless otherwise noted)

Characteristic	Symbol	Min	Typ	Max	Unit
----------------	--------	-----	-----	-----	------

OFF CHARACTERISTICS

Collector–Emitter Breakdown Voltage ($I_C = 2.0\text{ mA}, I_B = 0$)	BC237 BC238 BC239	$V_{(BR)CEO}$	45 25 25	— — —	— — —	V
Emitter–Base Breakdown Voltage ($I_E = 100\ \mu\text{A}, I_C = 0$)	BC237 BC238 BC239	$V_{(BR)EBO}$	6.0 5.0 5.0	— — —	— — —	V
Collector Cutoff Current ($V_{CE} = 30\text{ V}, V_{BE} = 0$)	BC238 BC239	I_{CES}	— —	0.2 0.2	15 15	nA
($V_{CE} = 50\text{ V}, V_{BE} = 0$)	BC237		—	0.2	15	
($V_{CE} = 30\text{ V}, V_{BE} = 0$) $T_A = 125^\circ\text{C}$	BC238 BC239		— —	0.2 0.2	4.0 4.0	μA
($V_{CE} = 50\text{ V}, V_{BE} = 0$) $T_A = 125^\circ\text{C}$	BC237		—	0.2	4.0	

BC237,A,B,C BC238B,C BC239,C
ELECTRICAL CHARACTERISTICS ($T_A = 25^\circ\text{C}$ unless otherwise noted) (Continued)

Characteristic	Symbol	Min	Typ	Max	Unit
ON CHARACTERISTICS					
DC Current Gain ($I_C = 10\ \mu\text{A}$, $V_{CE} = 5.0\ \text{V}$)	BC237A BC237B/238B BC237C/238C/239C	h_{FE}	— — —	90 150 270	— — —
($I_C = 2.0\ \text{mA}$, $V_{CE} = 5.0\ \text{V}$)	BC237 BC239 BC237A BC237B/238B BC237C/238C/239C		120 120 120 200 380	— — 170 290 500	800 800 220 460 800
($I_C = 100\ \text{mA}$, $V_{CE} = 5.0\ \text{V}$)	BC237A BC237B/238B BC237C/238C/239C		— — —	120 180 300	— — —
Collector–Emitter On Voltage ($I_C = 10\ \text{mA}$, $I_B = 0.5\ \text{mA}$) ($I_C = 100\ \text{mA}$, $I_B = 5.0\ \text{mA}$)	BC237/BC238/BC239 BC237/BC239 BC238	$V_{CE(sat)}$	— —	0.07 0.2	0.2 0.6 0.8
Base–Emitter Saturation Voltage ($I_C = 10\ \text{mA}$, $I_B = 0.5\ \text{mA}$) ($I_C = 100\ \text{mA}$, $I_B = 5.0\ \text{mA}$)		$V_{BE(sat)}$	— —	0.6 —	0.83 1.05
Base–Emitter On Voltage ($I_C = 100\ \mu\text{A}$, $V_{CE} = 5.0\ \text{V}$) ($I_C = 2.0\ \text{mA}$, $V_{CE} = 5.0\ \text{V}$) ($I_C = 100\ \text{mA}$, $V_{CE} = 5.0\ \text{V}$)		$V_{BE(on)}$	— 0.55 —	0.5 0.62 0.83	— 0.7 —
DYNAMIC CHARACTERISTICS					
Current–Gain — Bandwidth Product ($I_C = 0.5\ \text{mA}$, $V_{CE} = 3.0\ \text{V}$, $f = 100\ \text{MHz}$)	BC237 BC238 BC239	f_T	— — —	100 120 140	— — —
($I_C = 10\ \text{mA}$, $V_{CE} = 5.0\ \text{V}$, $f = 100\ \text{MHz}$)	BC237 BC238 BC239		150 150 150	200 240 280	— — —
Collector–Base Capacitance ($V_{CB} = 10\ \text{V}$, $I_C = 0$, $f = 1.0\ \text{MHz}$)		C_{obo}	—	—	4.5
Emitter–Base Capacitance ($V_{EB} = 0.5\ \text{V}$, $I_C = 0$, $f = 1.0\ \text{MHz}$)		C_{ibo}	—	8.0	—
Noise Figure ($I_C = 0.2\ \text{mA}$, $V_{CE} = 5.0\ \text{V}$, $R_S = 2.0\ \text{k}\Omega$, $f = 1.0\ \text{kHz}$)	BC239	NF	—	2.0	4.0
($I_C = 0.2\ \text{mA}$, $V_{CE} = 5.0\ \text{V}$, $R_S = 2.0\ \text{k}\Omega$, $f = 1.0\ \text{kHz}$, $\Delta f = 200\ \text{Hz}$)	BC237 BC238 BC239		— — —	2.0 2.0 2.0	10 10 4.0

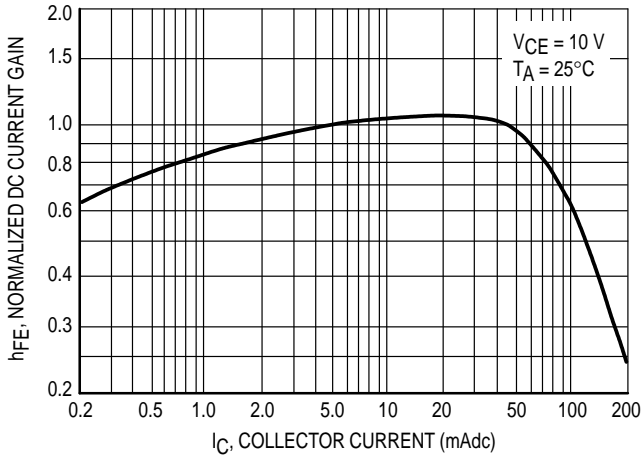

Figure 1. Normalized DC Current Gain

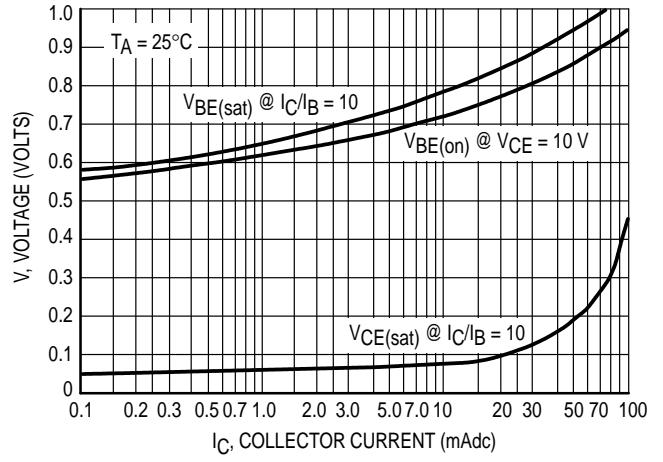

Figure 2. "Saturation" and "On" Voltages

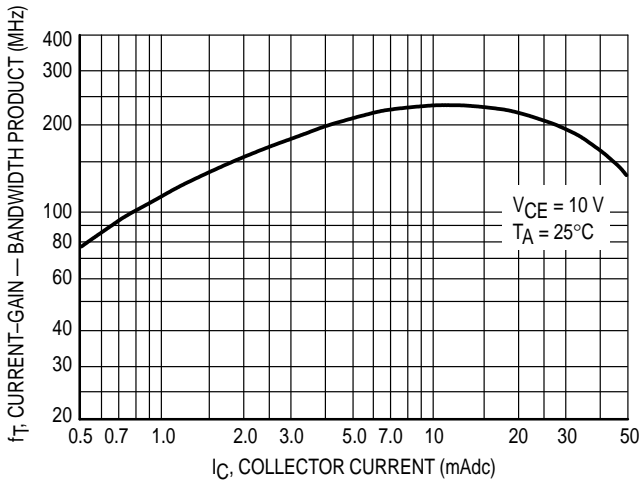

Figure 3. Current-Gain — Bandwidth Product

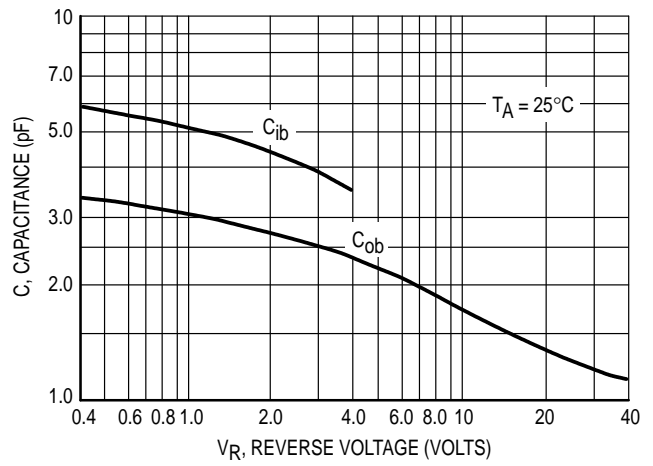

Figure 4. Capacitances

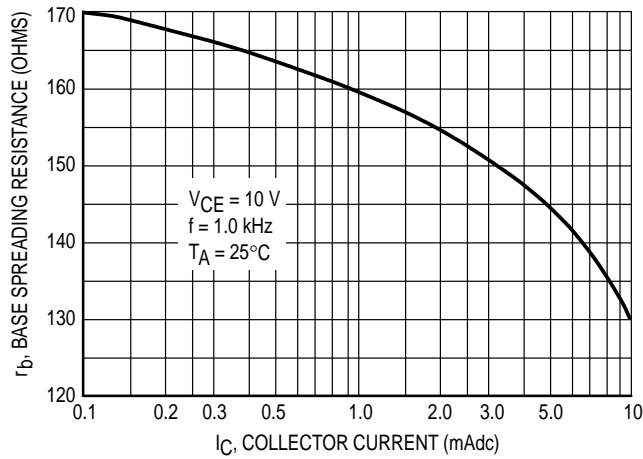
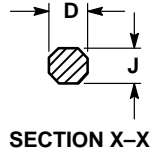
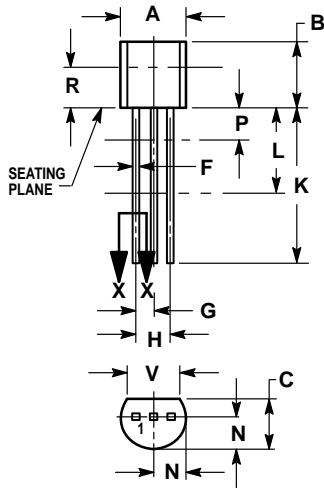

Figure 5. Base Spreading Resistance

PACKAGE DIMENSIONS



CASE 029-04
(TO-226AA)
ISSUE AD

NOTES:

1. DIMENSIONING AND TOLERANCING PER ANSI Y14.5M, 1982.
2. CONTROLLING DIMENSION: INCH.
3. CONTOUR OF PACKAGE BEYOND DIMENSION R IS UNCONTROLLED.
4. DIMENSION F APPLIES BETWEEN P AND L. DIMENSION D AND J APPLY BETWEEN L AND K. MINIMUM LEAD DIMENSION IS UNCONTROLLED IN P AND BEYOND DIMENSION K MINIMUM.

DIM	INCHES		MILLIMETERS	
	MIN	MAX	MIN	MAX
A	0.175	0.205	4.45	5.20
B	0.170	0.210	4.32	5.33
C	0.125	0.165	3.18	4.19
D	0.016	0.022	0.41	0.55
F	0.016	0.019	0.41	0.48
G	0.045	0.055	1.15	1.39
H	0.095	0.105	2.42	2.66
J	0.015	0.020	0.39	0.50
K	0.500	—	12.70	—
L	0.250	—	6.35	—
N	0.080	0.105	2.04	2.66
P	—	0.100	—	2.54
R	0.115	—	2.93	—
V	0.135	—	3.43	—

STYLE 17:

- PIN 1. COLLECTOR
2. BASE
3. EMITTER

Motorola reserves the right to make changes without further notice to any products herein. Motorola makes no warranty, representation or guarantee regarding the suitability of its products for any particular purpose, nor does Motorola assume any liability arising out of the application or use of any product or circuit, and specifically disclaims any and all liability, including without limitation consequential or incidental damages. "Typical" parameters can and do vary in different applications. All operating parameters, including "Typicals" must be validated for each customer application by customer's technical experts. Motorola does not convey any license under its patent rights nor the rights of others. Motorola products are not designed, intended, or authorized for use as components in systems intended for surgical implant into the body, or other applications intended to support or sustain life, or for any other application in which the failure of the Motorola product could create a situation where personal injury or death may occur. Should Buyer purchase or use Motorola products for any such unintended or unauthorized application, Buyer shall indemnify and hold Motorola and its officers, employees, subsidiaries, affiliates, and distributors harmless against all claims, costs, damages, and expenses, and reasonable attorney fees arising out of, directly or indirectly, any claim of personal injury or death associated with such unintended or unauthorized use, even if such claim alleges that Motorola was negligent regarding the design or manufacture of the part. Motorola and are registered trademarks of Motorola, Inc. Motorola, Inc. is an Equal Opportunity/Affirmative Action Employer.

How to reach us:

USA/EUROPE: Motorola Literature Distribution;
P.O. Box 20912; Phoenix, Arizona 85036. 1-800-441-2447

JAPAN: Nippon Motorola Ltd.; Tatsumi-SPD-JLDC, Toshikatsu Otsuki,
6F Seibu-Butsuryu-Center, 3-14-2 Tatsumi Koto-Ku, Tokyo 135, Japan. 03-3521-8315

MFAX: RMFAX0@email.sps.mot.com - TOUCHTONE (602) 244-6609
INTERNET: http://Design-NET.com

HONG KONG: Motorola Semiconductors H.K. Ltd.; 8B Tai Ping Industrial Park,
51 Ting Kok Road, Tai Po, N.T., Hong Kong. 852-26629298

