

BC817-16L, SBC817-16L, BC817-25L, SBC817-25L, BC817-40L, SBC817-40L

General Purpose Transistors

NPN Silicon

Features

- S Prefix for Automotive and Other Applications Requiring Unique Site and Control Change Requirements; AEC-Q101 Qualified and PPAP Capable
- These Devices are Pb-Free, Halogen Free/BFR Free and are RoHS Compliant

MAXIMUM RATINGS

Rating	Symbol	Value	Unit
Collector – Emitter Voltage	V_{CEO}	45	V
Collector – Base Voltage	V_{CBO}	50	V
Emitter – Base Voltage	V_{EBO}	5.0	V
Collector Current – Continuous	I_C	500	mAdc

THERMAL CHARACTERISTICS

Characteristic	Symbol	Max	Unit
Total Device Dissipation FR-5 Board, (Note 1) $T_A = 25^\circ\text{C}$ Derate above 25°C	P_D	225 1.8	mW mW/ $^\circ\text{C}$
Thermal Resistance, Junction-to-Ambient	$R_{\theta JA}$	556	$^\circ\text{C}/\text{W}$
Total Device Dissipation Alumina Substrate, (Note 2) $T_A = 25^\circ\text{C}$ Derate above 25°C	P_D	300 2.4	mW mW/ $^\circ\text{C}$
Thermal Resistance, Junction-to-Ambient	$R_{\theta JA}$	417	$^\circ\text{C}/\text{W}$
Junction and Storage Temperature	T_J, T_{stg}	-65 to +150	$^\circ\text{C}$

Stresses exceeding Maximum Ratings may damage the device. Maximum Ratings are stress ratings only. Functional operation above the Recommended Operating Conditions is not implied. Extended exposure to stresses above the Recommended Operating Conditions may affect device reliability.

1. FR-5 = 1.0 x 0.75 x 0.062 in.
2. Alumina = 0.4 x 0.3 x 0.024 in 99.5% alumina.



ON Semiconductor®

<http://onsemi.com>

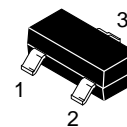
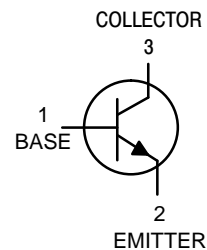

SOT-23
CASE 318
STYLE 6

MARKING DIAGRAM

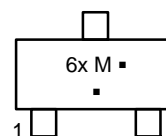

6x = Device Code
x = A, B, or C
M = Date Code*
■ = Pb-Free Package

(Note: Microdot may be in either location)

*Date Code orientation and/or overbar may vary depending upon manufacturing location.

ORDERING INFORMATION

See detailed ordering and shipping information in the package dimensions section on page 2 of this data sheet.

BC817-16L, SBC817-16L, BC817-25L, SBC817-25L, BC817-40L, SBC817-40L

ELECTRICAL CHARACTERISTICS (T_A = 25°C unless otherwise noted)

Characteristic	Symbol	Min	Typ	Max	Unit
OFF CHARACTERISTICS					
Collector-Emitter Breakdown Voltage (I _C = 10 mA)	V _{(BR)CEO}	45	-	-	V
Collector-Emitter Breakdown Voltage (V _{EB} = 0, I _C = 10 μA)	V _{(BR)CES}	50	-	-	V
Emitter-Base Breakdown Voltage (I _E = 1.0 μA)	V _{(BR)EBO}	5.0	-	-	V
Collector Cutoff Current (V _{CB} = 20 V) (V _{CB} = 20 V, T _A = 150°C)	I _{CBO}	-	-	100 5.0	nA μA

ON CHARACTERISTICS

DC Current Gain (I _C = 100 mA, V _{CE} = 1.0 V)	BC817-16, SBC817-16 BC817-25, SBC817-25 BC817-40, SBC817-40	h _{FE}	100	-	250	-
(I _C = 500 mA, V _{CE} = 1.0 V)			160	-	400	-
			250	-	600	-
			40	-	-	-
Collector-Emitter Saturation Voltage (I _C = 500 mA, I _B = 50 mA)	V _{CE(sat)}	-	-	0.7	V	
Base-Emitter On Voltage (I _C = 500 mA, V _{CE} = 1.0 V)	V _{BE(on)}	-	-	1.2	V	

SMALL-SIGNAL CHARACTERISTICS

Current-Gain - Bandwidth Product (I _C = 10 mA, V _{CE} = 5.0 Vdc, f = 100 MHz)	f _T	100	-	-	MHz
Output Capacitance (V _{CB} = 10 V, f = 1.0 MHz)	C _{obo}	-	10	-	pF

ORDERING INFORMATION

Device	Specific Marking	Package	Shipping†
BC817-16LT1G	6A	SOT-23 (Pb-Free)	3000 / Tape & Reel
BC817-16LT3G			10,000 / Tape & Reel
SBC817-16LT3			
BC817-25LT1G	6B	SOT-23 (Pb-Free)	3000 / Tape & Reel
SBC817-25LT1G			
BC817-25LT3G			10,000 / Tape & Reel
SBC817-25LT3G			
BC817-40LT1G	6C	SOT-23 (Pb-Free)	3000 / Tape & Reel
SBC817-40LT1G			
BC817-40LT3G			10,000 / Tape & Reel
SBC817-40LT3G			

†For information on tape and reel specifications, including part orientation and tape sizes, please refer to our Tape and Reel Packaging Specifications Brochure, BRD8011/D.

TYPICAL CHARACTERISTICS – BC817-16L, SBC817-16L

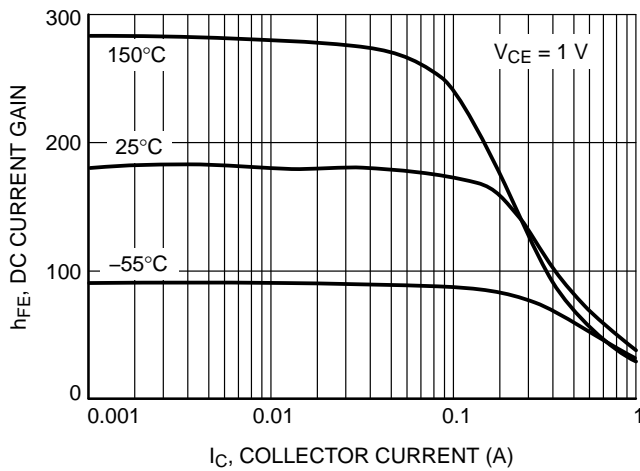

Figure 1. DC Current Gain vs. Collector Current

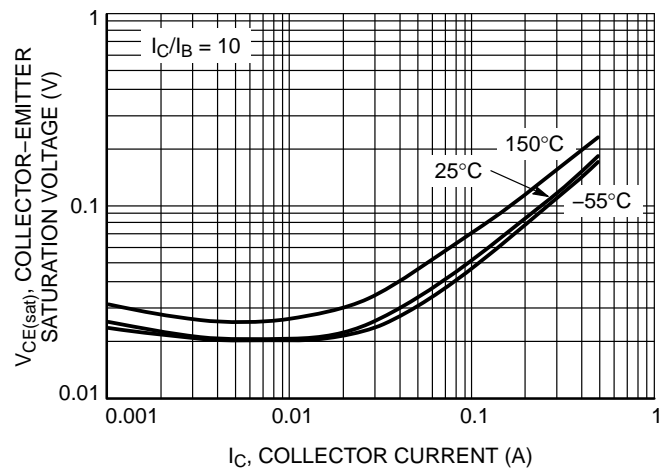

Figure 2. Collector Emitter Saturation Voltage vs. Collector Current

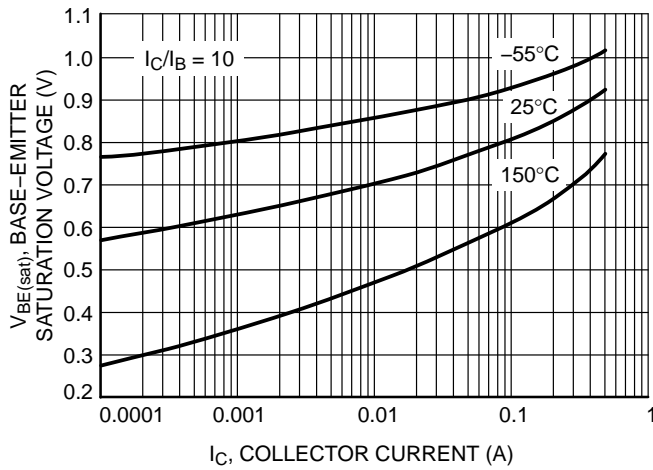

Figure 3. Base Emitter Saturation Voltage vs. Collector Current

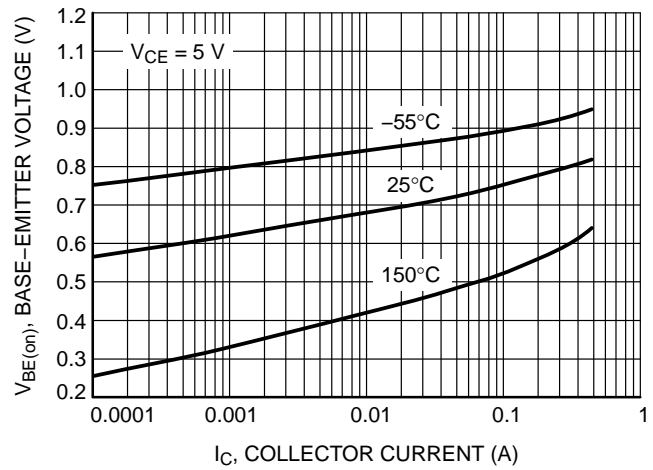

Figure 4. Base Emitter Voltage vs. Collector Current

TYPICAL CHARACTERISTICS - BC817-16L, SBC817-16L

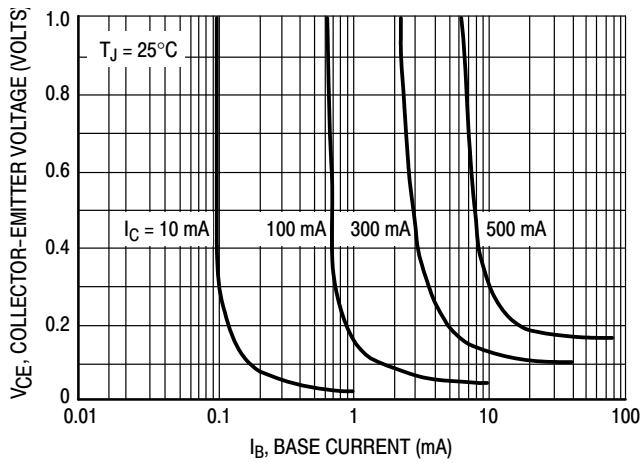

Figure 5. Saturation Region

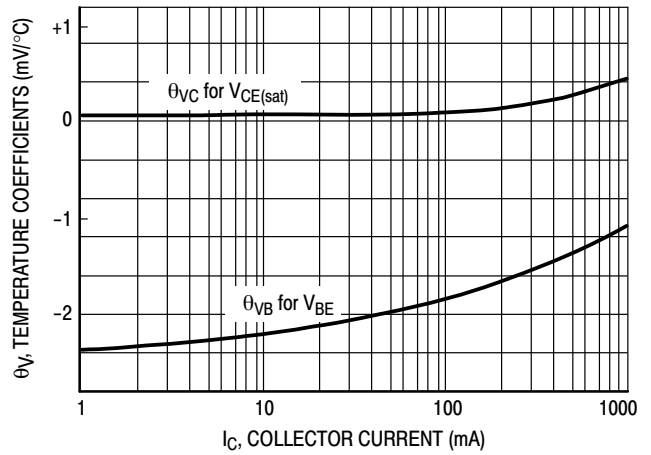

Figure 6. Temperature Coefficients

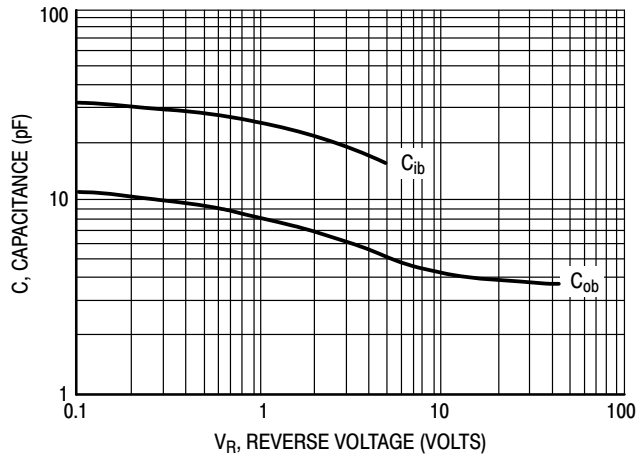

Figure 7. Capacitances

TYPICAL CHARACTERISTICS – BC817-25L, SBC817-25L

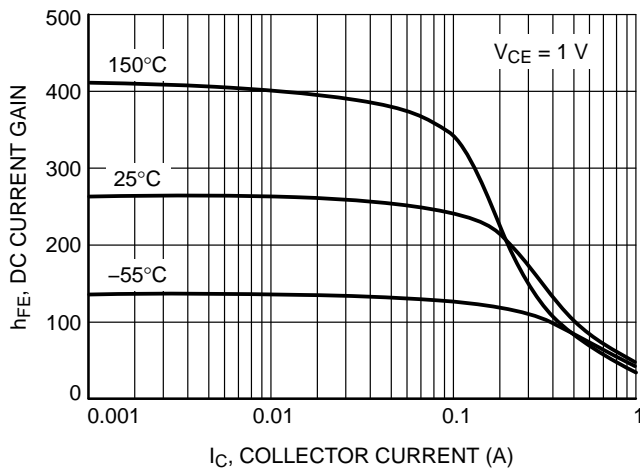

Figure 8. DC Current Gain vs. Collector Current

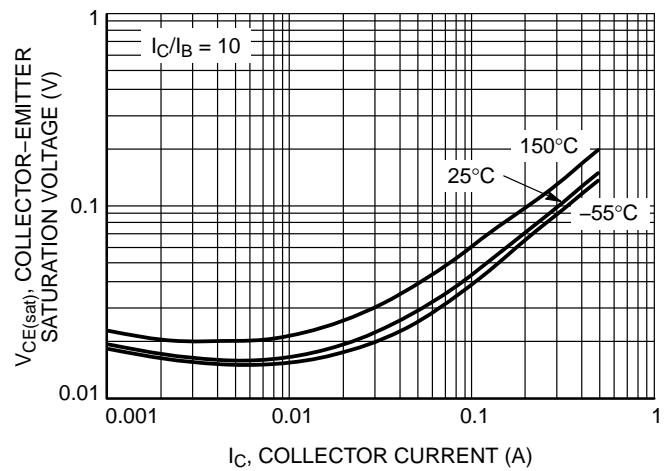

Figure 9. Collector Emitter Saturation Voltage vs. Collector Current

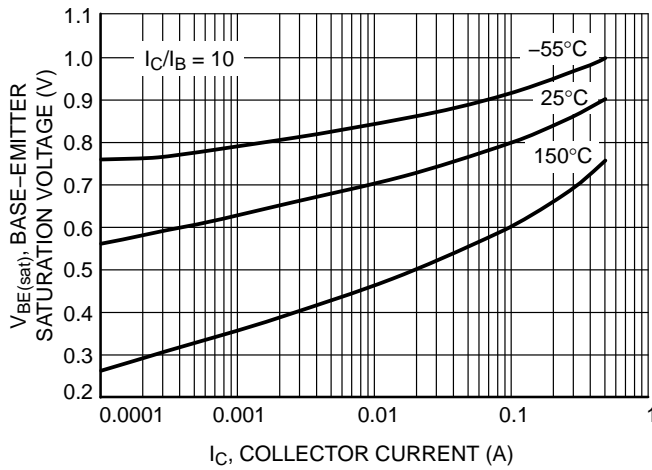

Figure 10. Base Emitter Saturation Voltage vs. Collector Current

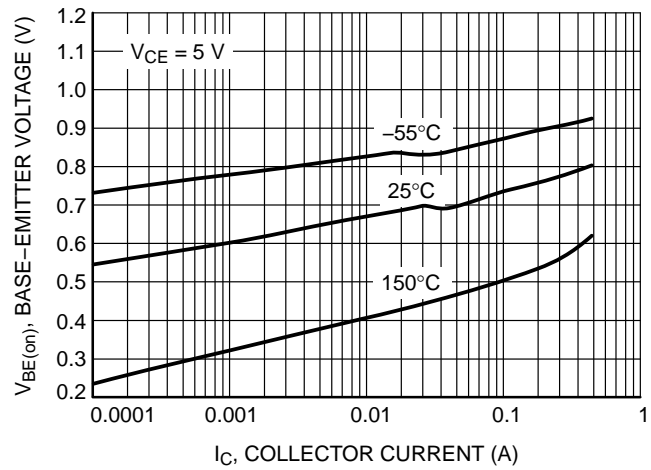

Figure 11. Base Emitter Voltage vs. Collector Current

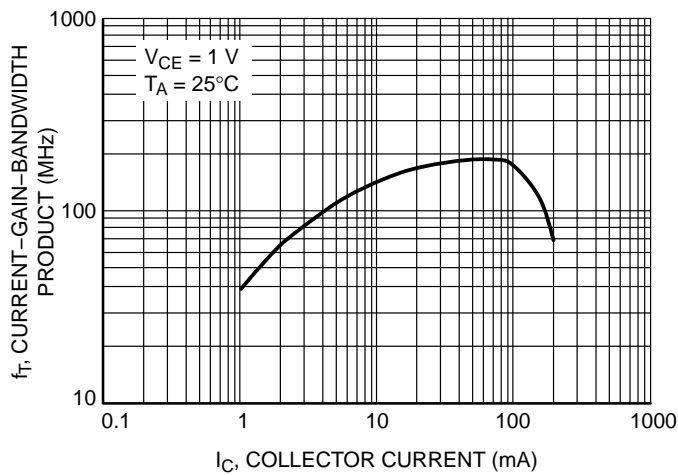

Figure 12. Current Gain Bandwidth Product vs. Collector Current

TYPICAL CHARACTERISTICS – BC817-25L, SBC81725L

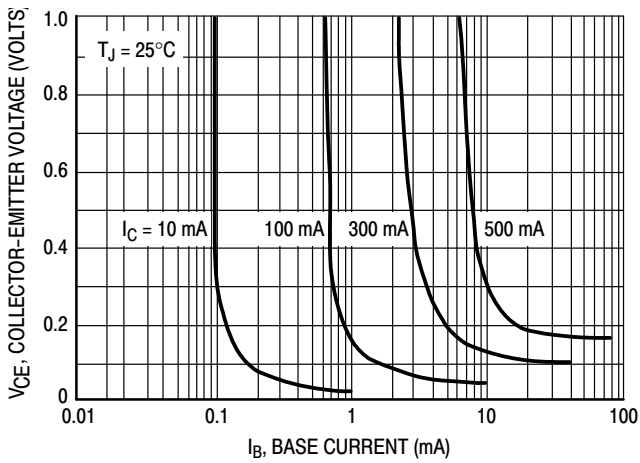

Figure 13. Saturation Region

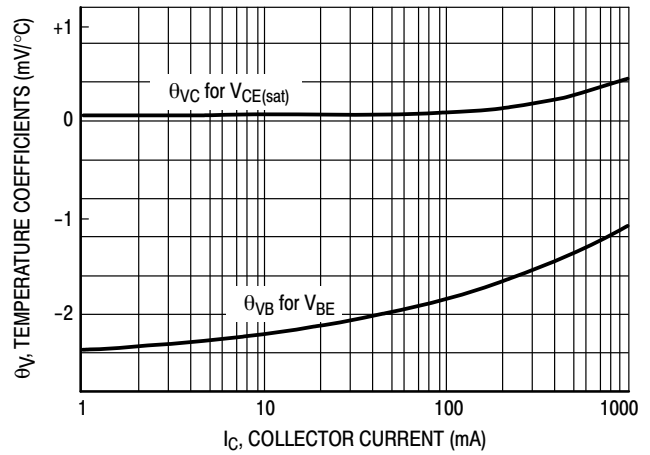

Figure 14. Temperature Coefficients

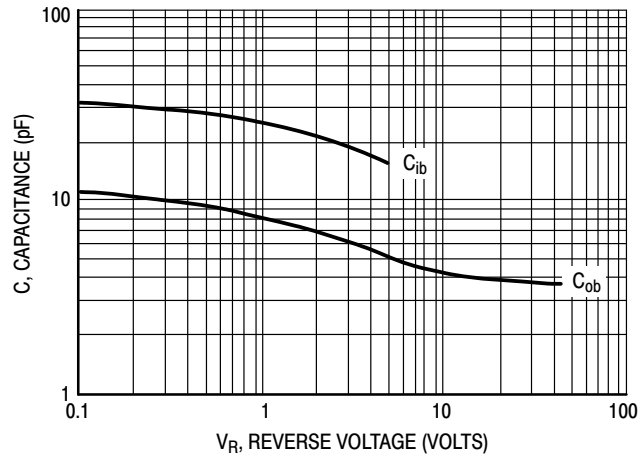

Figure 15. Capacitances

TYPICAL CHARACTERISTICS - BC817-40L, SBC817-40L

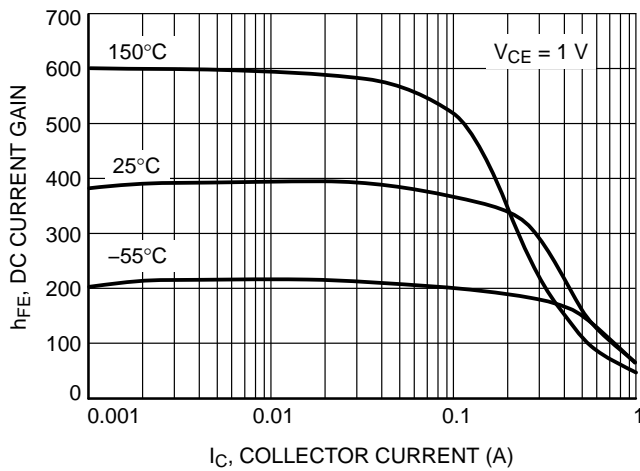

Figure 16. DC Current Gain vs. Collector Current

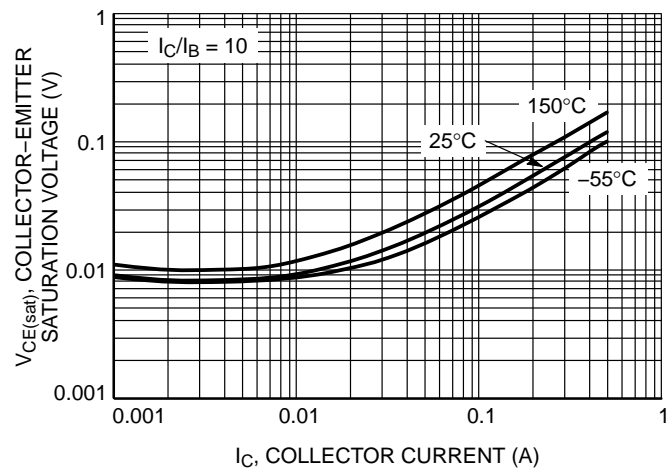

Figure 17. Collector Emitter Saturation Voltage vs. Collector Current

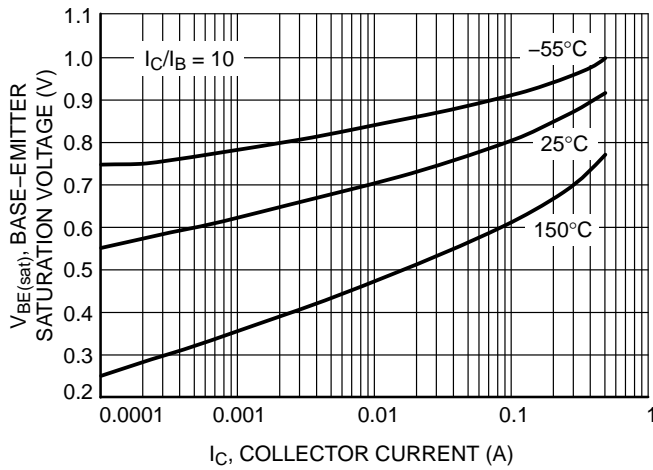

Figure 18. Base Emitter Saturation Voltage vs. Collector Current

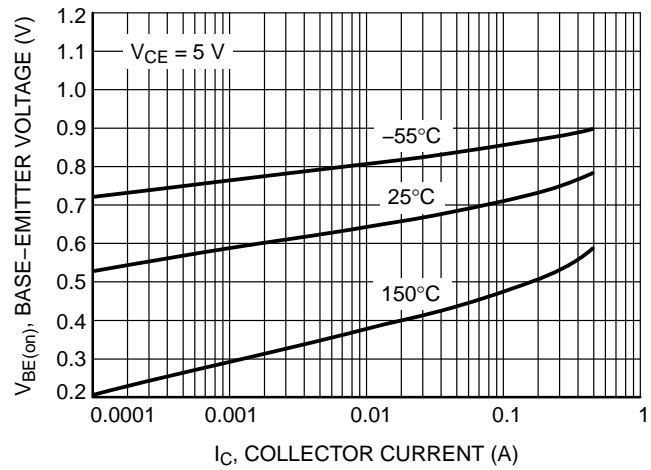

Figure 19. Base Emitter Voltage vs. Collector Current

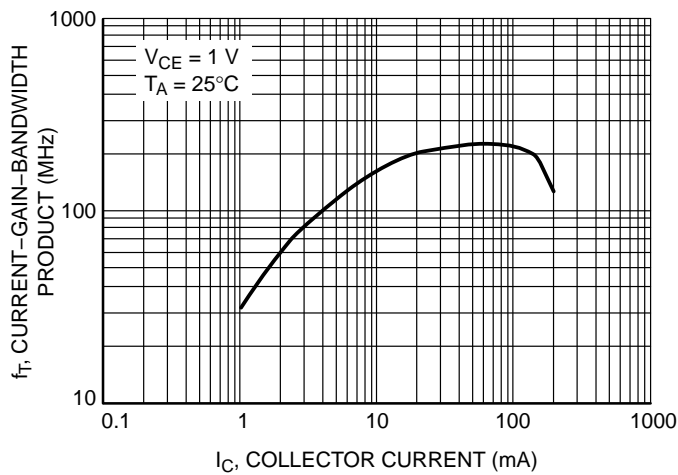

Figure 20. Current Gain Bandwidth Product vs. Collector Current

TYPICAL CHARACTERISTICS - BC817-40L, SBC817-40L

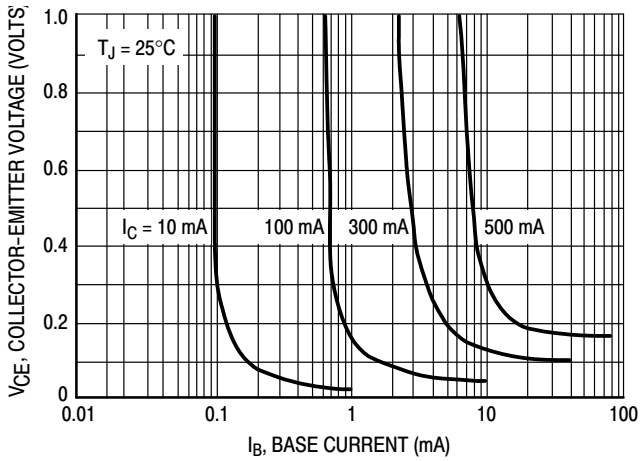

Figure 21. Saturation Region

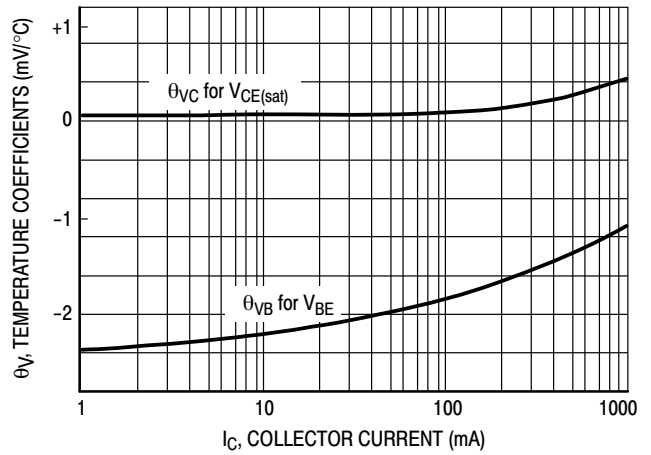

Figure 22. Temperature Coefficients

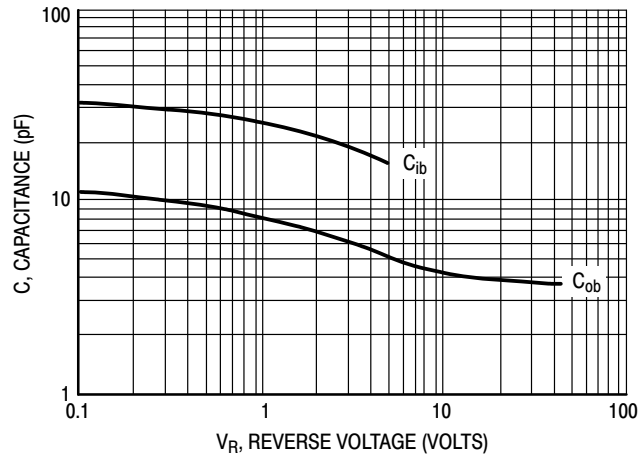

Figure 23. Capacitances

BC817-16L, SBC817-16L, BC817-25L, SBC817-25L, BC817-40L, SBC817-40L

TYPICAL CHARACTERISTICS – BC817-16L, SBC817-16L, BC817-25L, SBC817-25L, BC817-40L, SBC817-40L

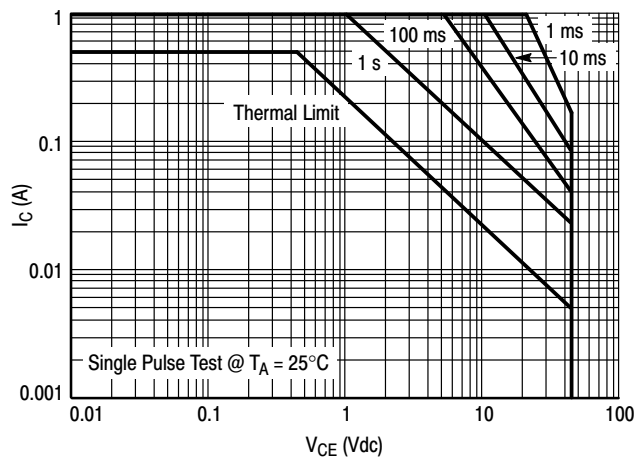
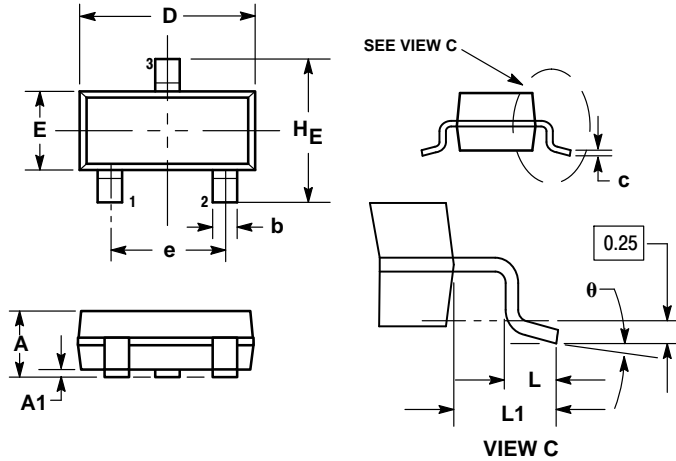

Figure 24. Safe Operating Area

BC817-16L, SBC817-16L, BC817-25L, SBC817-25L, BC817-40L, SBC817-40L

PACKAGE DIMENSIONS

SOT-23 (TO-236) CASE 318-08 ISSUE AP



- NOTES:
1. DIMENSIONING AND TOLERANCING PER ANSI Y14.5M, 1982.
 2. CONTROLLING DIMENSION: INCH.
 3. MAXIMUM LEAD THICKNESS INCLUDES LEAD FINISH THICKNESS. MINIMUM LEAD THICKNESS IS THE MINIMUM THICKNESS OF BASE MATERIAL.
 4. DIMENSIONS D AND E DO NOT INCLUDE MOLD FLASH, PROTRUSIONS, OR GATE BURRS.

DIM	MILLIMETERS			INCHES		
	MIN	NOM	MAX	MIN	NOM	MAX
A	0.89	1.00	1.11	0.035	0.040	0.044
A1	0.01	0.06	0.10	0.001	0.002	0.004
b	0.37	0.44	0.50	0.015	0.018	0.020
c	0.09	0.13	0.18	0.003	0.005	0.007
D	2.80	2.90	3.04	0.110	0.114	0.120
E	1.20	1.30	1.40	0.047	0.051	0.055
e	1.78	1.90	2.04	0.070	0.075	0.081
L	0.10	0.20	0.30	0.004	0.008	0.012
L1	0.35	0.54	0.69	0.014	0.021	0.029
HE	2.10	2.40	2.64	0.083	0.094	0.104
θ	0°	---	10°	0°	---	10°

STYLE 6:
PIN 1. BASE
2. EMITTER
3. COLLECTOR

SOLDERING FOOTPRINT*

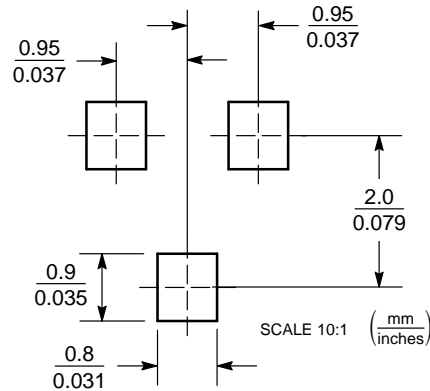

*For additional information on our Pb-Free strategy and soldering details, please download the ON Semiconductor Soldering and Mounting Techniques Reference Manual, SOLDERRM/D.

ON Semiconductor and are registered trademarks of Semiconductor Components Industries, LLC (SCILLC). SCILLC reserves the right to make changes without further notice to any products herein. SCILLC makes no warranty, representation or guarantee regarding the suitability of its products for any particular purpose, nor does SCILLC assume any liability arising out of the application or use of any product or circuit, and specifically disclaims any and all liability, including without limitation special, consequential or incidental damages. "Typical" parameters which may be provided in SCILLC data sheets and/or specifications can and do vary in different applications and actual performance may vary over time. All operating parameters, including "Typicals" must be validated for each customer application by customer's technical experts. SCILLC does not convey any license under its patent rights nor the rights of others. SCILLC products are not designed, intended, or authorized for use as components in systems intended for surgical implant into the body, or other applications intended to support or sustain life, or for any other application in which the failure of the SCILLC product could create a situation where personal injury or death may occur. Should Buyer purchase or use SCILLC products for any such unintended or unauthorized application, Buyer shall indemnify and hold SCILLC and its officers, employees, subsidiaries, affiliates, and distributors harmless against all claims, costs, damages, and expenses, and reasonable attorney fees arising out of, directly or indirectly, any claim of personal injury or death associated with such unintended or unauthorized use, even if such claim alleges that SCILLC was negligent regarding the design or manufacture of the part. SCILLC is an Equal Opportunity/Affirmative Action Employer. This literature is subject to all applicable copyright laws and is not for resale in any manner.

PUBLICATION ORDERING INFORMATION

LITERATURE FULFILLMENT:
Literature Distribution Center for ON Semiconductor
P.O. Box 5163, Denver, Colorado 80217 USA
Phone: 303-675-2175 or 800-344-3860 Toll Free USA/Canada
Fax: 303-675-2176 or 800-344-3867 Toll Free USA/Canada
Email: orderlit@onsemi.com

N. American Technical Support: 800-282-9855 Toll Free
USA/Canada
Europe, Middle East and Africa Technical Support:
Phone: 421 33 790 2910
Japan Customer Focus Center
Phone: 81-3-5817-1050

ON Semiconductor Website: www.onsemi.com
Order Literature: <http://www.onsemi.com/orderlit>
For additional information, please contact your local Sales Representative