



**FMMT625**

**150V NPN SILICON LOW SATURATION TRANSISTOR IN SOT23**

**Features**

- $BV_{CEO} > 150V$
- Maximum Continuous Collector Current  $I_C = 1A$
- 625mW Power dissipation
- $h_{FE}$  characterised up to 3.0A
- **Totally Lead-Free & Fully RoHS compliant (Notes 1 & 2)**
- **Halogen and Antimony Free. "Green" Device (Note 3)**
- **Qualified to AEC-Q101 Standards for High Reliability**
- **PPAP capable (Note 4)**

**Mechanical Data**

- Case: SOT23
- Case Material: molded plastic, "Green" molding compound
- UL Flammability Classification Rating 94V-0
- Moisture Sensitivity: Level 1 per J-STD-020
- Terminals: Finish – Matte Tin Plated Leads, Solderable per MIL-STD-202, Method 208 (E3)
- Weight 0.008 grams (approximate)

**Applications**

- DC-DC Modules
- Power Management Functions
- Motor control and drive functions



Top View

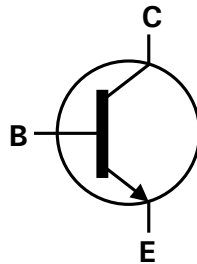

Device Symbol

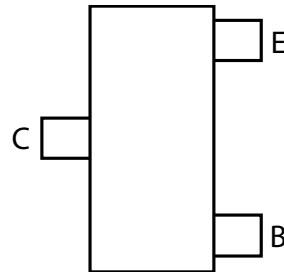

Top View  
Pin-Out

**Ordering Information** (Note 4 & 5)

Product	Compliance	Marking	Reel size (inches)	Tape width (mm)	Quantity per reel
FMMT625TA	AEC-Q101	625	7	8	3000 units
FMMT625QTA	Automotive	625	7	8	3000 units

- Notes:
1. No purposely added lead. Fully EU Directive 2002/95/EC (RoHS) & 2011/65/EU (RoHS 2) compliant.
  2. See <http://www.diodes.com> for more information about Diodes Incorporated's definitions of Halogen and Antimony free, "Green" and Lead-Free.
  3. Halogen and Antimony free "Green" products are defined as those which contain <900ppm bromine, <900ppm chlorine (<1500ppm total Br + Cl) and <1000ppm antimony compounds.
  4. Automotive products are AEC-Q101 qualified and are PPAP capable. Automotive, AEC-Q101 and standard products are electrically and thermally the same, except where specified.
  5. For packaging details, go to our website at <http://www.diodes.com>

**Marking Information**

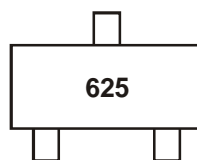

625 = Product Type Marking Code

**Maximum Ratings** (@T<sub>A</sub> = +25°C, unless otherwise specified.)

Characteristic	Symbol	Value	Unit
Collector-Base Voltage	V <sub>CB0</sub>	150	V
Collector-Emitter Voltage	V <sub>CEO</sub>	150	V
Emitter-Base Voltage	V <sub>EBO</sub>	5	V
Continuous Collector Current	I <sub>C</sub>	1	A
Peak Pulse Current	I <sub>CM</sub>	3	A
Base Current	I <sub>B</sub>	500	mA

**Thermal Characteristics** (@T<sub>A</sub> = +25°C, unless otherwise specified.)

Characteristic	Symbol	Value	Unit
Power Dissipation (Note 6)	P <sub>D</sub>	625	mW
Thermal Resistance, Junction to Ambient (Note 6)	R <sub>θJA</sub>	200	°C/W
Thermal Resistance, Junction to Leads (Note 7)	R <sub>θJL</sub>	194	°C/W
Operating and Storage Temperature Range	T <sub>J</sub> , T <sub>STG</sub>	-55 to +150	°C

**ESD Ratings** (Note 8)

Characteristic	Symbol	Value	Unit	JEDEC Class
Electrostatic Discharge - Human Body Model	ESD HBM	≥ 8,000	V	3B
Electrostatic Discharge - Machine Model	ESD MM	≥ 400	V	C

- Notes:
6. For a device surface mounted on 25mm X 25mm FR4 PCB with high coverage of single sided 1 oz copper, in still air conditions.
  7. Thermal resistance from junction to solder-point (at the end of the collector lead).
  8. Refer to JEDEC specification JESD22-A114 and JESD22-A115.

**Thermal Characteristics and Derating information**

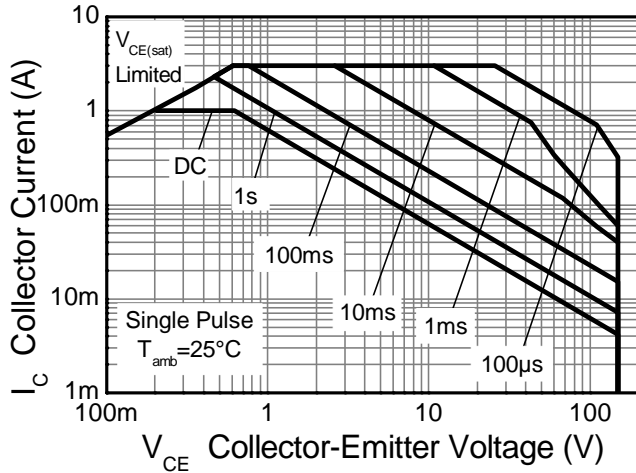

**Safe Operating Area**

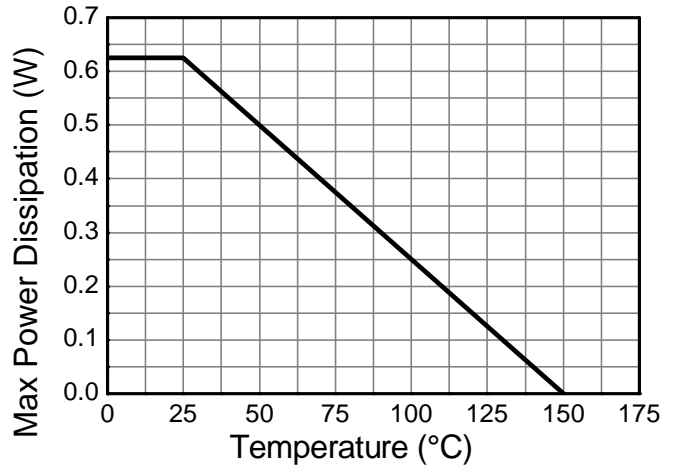

**Derating Curve**

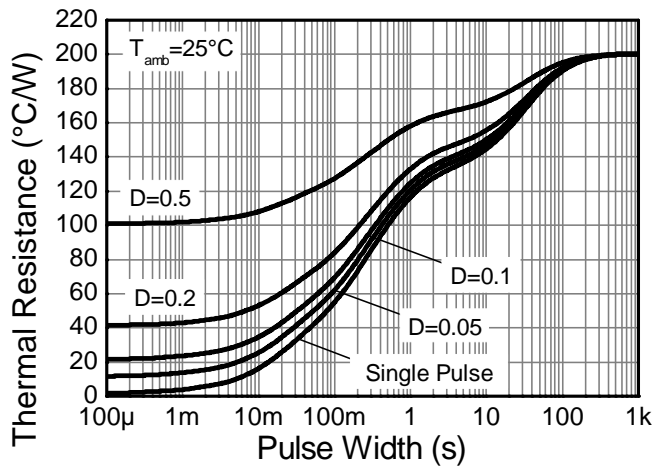

**Transient Thermal Impedance**

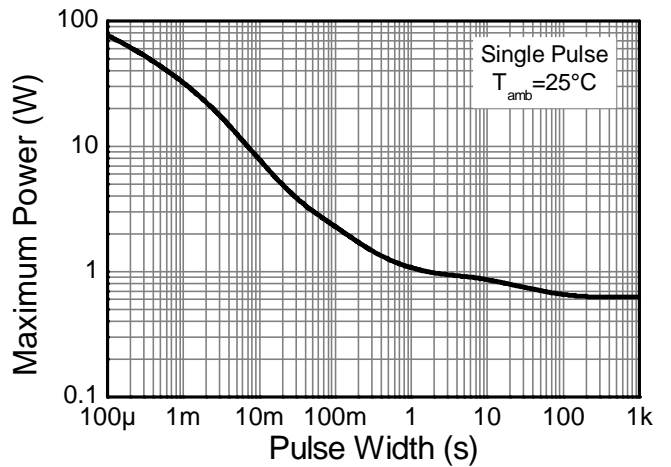

**Pulse Power Dissipation**

**Electrical Characteristics** (@T<sub>A</sub> = +25°C, unless otherwise specified.)

Characteristic	Symbol	Min	Typ	Max	Unit	Test Condition
Collector-Base Breakdown Voltage	BV <sub>CBO</sub>	150	300	-	V	I <sub>C</sub> = 100μA
Collector-Emitter Breakdown Voltage (Note 9)	BV <sub>CEO</sub>	150	175	-	V	I <sub>C</sub> = 1mA
Emitter-Base Breakdown Voltage	BV <sub>EBO</sub>	5	8.3	-	V	I <sub>E</sub> = 100μA
Collector Cut-off Current	I <sub>CBO</sub>	-	-	100	nA	V <sub>CB</sub> = 130V
Emitter Cut-off Current	I <sub>EBO</sub>	-	-	100	nA	V <sub>EB</sub> = 5V
Collector Emitter Cut-off Current	I <sub>CES</sub>	-	-	100	nA	V <sub>CES</sub> = 130V
Static Forward Current Transfer Ratio (Note 9)	h <sub>FE</sub>	200 300 30 -	400 450 45 15	- - - -	-	I <sub>C</sub> = 10mA, V <sub>CE</sub> = 10V I <sub>C</sub> = 200mA, V <sub>CE</sub> = 10V I <sub>C</sub> = 1A, V <sub>CE</sub> = 10V I <sub>C</sub> = 3A, V <sub>CE</sub> = 10V
Collector-Emitter Saturation Voltage (Note 9)	V <sub>CE(sat)</sub>	- - -	26 110 180	50 200 300	mV	I <sub>C</sub> = 0.1A, I <sub>B</sub> = 10mA I <sub>C</sub> = 0.1A, I <sub>B</sub> = 1mA I <sub>C</sub> = 1A, I <sub>B</sub> = 50mA
Base-Emitter Saturation Voltage (Note 9)	V <sub>BE(sat)</sub>	-	0.85	1.0	V	I <sub>C</sub> = 1A, I <sub>B</sub> = 50mA
Base-Emitter Saturation Voltage (Note 9)	V <sub>BE(on)</sub>	-	0.74	1.0	V	I <sub>C</sub> = 1A, V <sub>CE</sub> = 10V
Transition Frequency	f <sub>T</sub>	100	135	-	MHz	I <sub>C</sub> = 50mA, V <sub>CE</sub> = 10V, f = 100MHz
Collector Output Capacitance	C <sub>obo</sub>	-	6	10	pF	V <sub>CB</sub> = 10V, f = 1MHz
Turn-On Time	t <sub>(on)</sub>	-	160	-	ns	V <sub>CC</sub> = 50V, I <sub>C</sub> = 500mA,
Turn-Off Time	t <sub>(off)</sub>	-	1500	-	ns	I <sub>B1</sub> = -I <sub>B2</sub> = 50mA

Notes: 9. Measured under pulsed conditions. Pulse width ≤ 300μs. Duty cycle ≤ 2%

**Typical Electrical Characteristics** (@T<sub>A</sub> = +25°C, unless otherwise specified.)

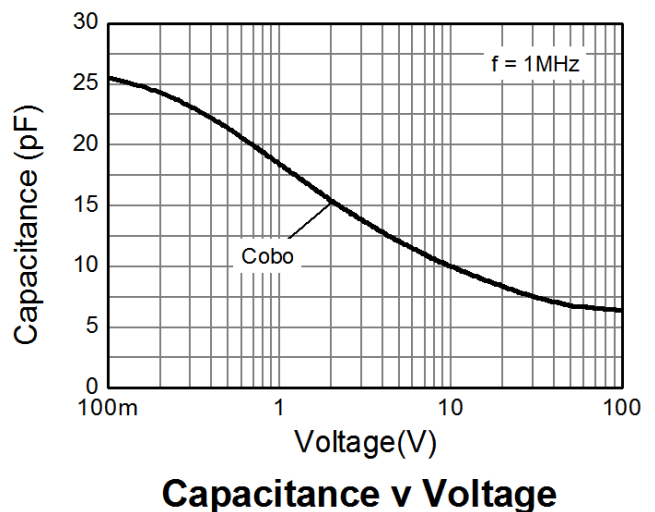
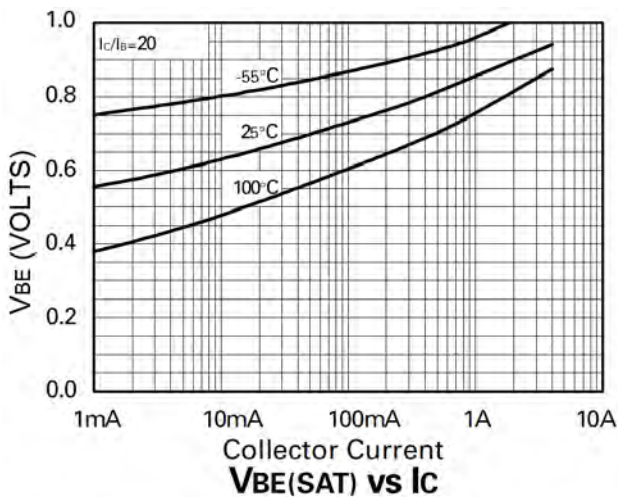
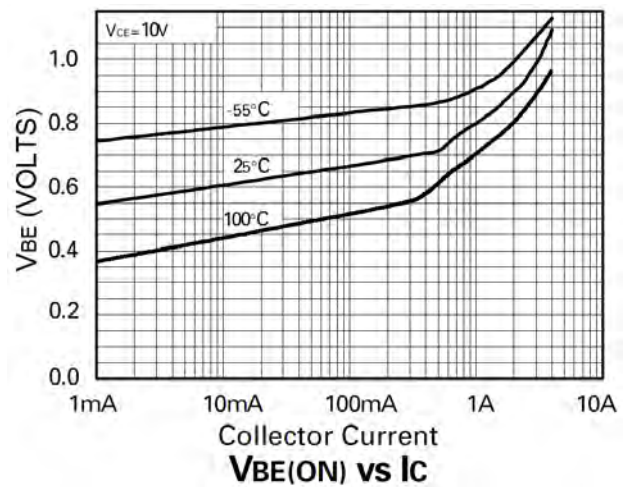
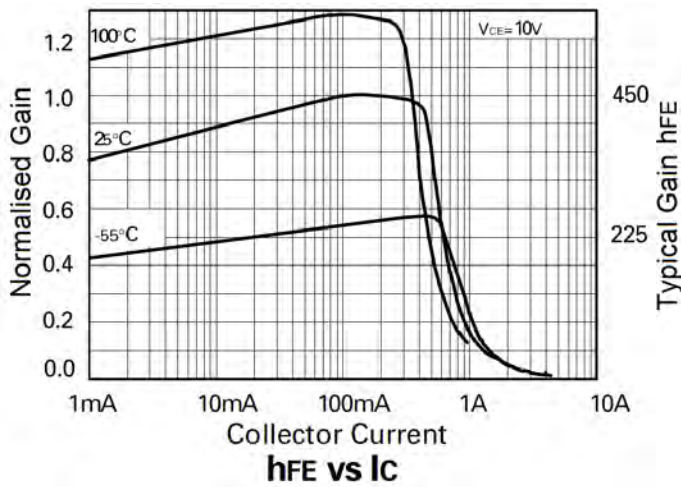
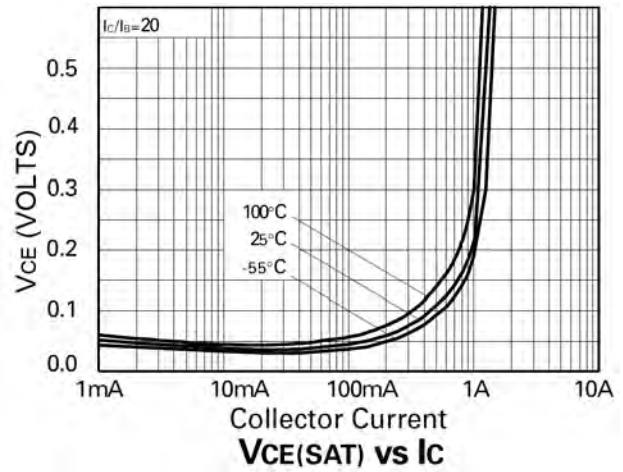
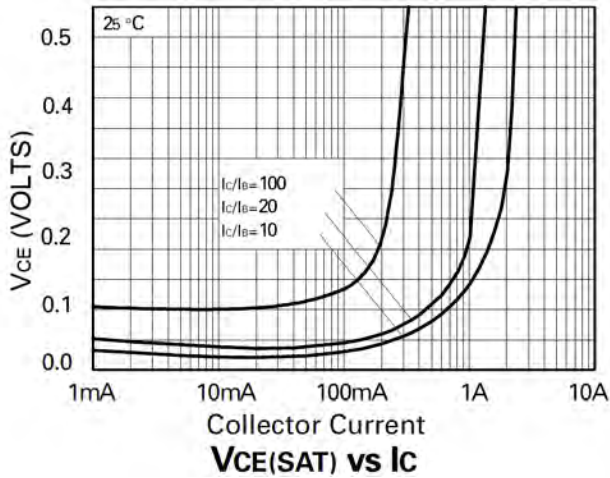

**Package Outline Dimensions**

Please see AP02002 at <http://www.diodes.com/datasheets/ap02002.pdf> for latest version.

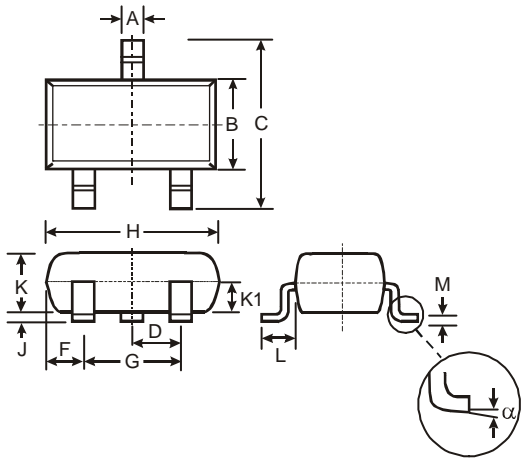

SOT23			
Dim	Min	Max	Typ
A	0.37	0.51	0.40
B	1.20	1.40	1.30
C	2.30	2.50	2.40
D	0.89	1.03	0.915
F	0.45	0.60	0.535
G	1.78	2.05	1.83
H	2.80	3.00	2.90
J	0.013	0.10	0.05
K	0.903	1.10	1.00
K1	-	-	0.400
L	0.45	0.61	0.55
M	0.085	0.18	0.11
α	0°	8°	-

**All Dimensions in mm**

**Suggested Pad Layout**

Please see AP02001 at <http://www.diodes.com/datasheets/ap02001.pdf> for the latest version.

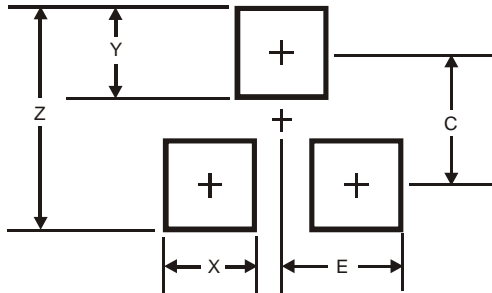

Dimensions	Value (in mm)
Z	2.9
X	0.8
Y	0.9
C	2.0
E	1.35

#### **IMPORTANT NOTICE**

DIODES INCORPORATED MAKES NO WARRANTY OF ANY KIND, EXPRESS OR IMPLIED, WITH REGARDS TO THIS DOCUMENT, INCLUDING, BUT NOT LIMITED TO, THE IMPLIED WARRANTIES OF MERCHANTABILITY AND FITNESS FOR A PARTICULAR PURPOSE (AND THEIR EQUIVALENTS UNDER THE LAWS OF ANY JURISDICTION).

Diodes Incorporated and its subsidiaries reserve the right to make modifications, enhancements, improvements, corrections or other changes without further notice to this document and any product described herein. Diodes Incorporated does not assume any liability arising out of the application or use of this document or any product described herein; neither does Diodes Incorporated convey any license under its patent or trademark rights, nor the rights of others. Any Customer or user of this document or products described herein in such applications shall assume all risks of such use and will agree to hold Diodes Incorporated and all the companies whose products are represented on Diodes Incorporated website, harmless against all damages.

Diodes Incorporated does not warrant or accept any liability whatsoever in respect of any products purchased through unauthorized sales channel. Should Customers purchase or use Diodes Incorporated products for any unintended or unauthorized application, Customers shall indemnify and hold Diodes Incorporated and its representatives harmless against all claims, damages, expenses, and attorney fees arising out of, directly or indirectly, any claim of personal injury or death associated with such unintended or unauthorized application.

Products described herein may be covered by one or more United States, international or foreign patents pending. Product names and markings noted herein may also be covered by one or more United States, international or foreign trademarks.

#### **LIFE SUPPORT**

Diodes Incorporated products are specifically not authorized for use as critical components in life support devices or systems without the express written approval of the Chief Executive Officer of Diodes Incorporated. As used herein:

A. Life support devices or systems are devices or systems which:

1. are intended to implant into the body, or
2. support or sustain life and whose failure to perform when properly used in accordance with instructions for use provided in the labeling can be reasonably expected to result in significant injury to the user.

B. A critical component is any component in a life support device or system whose failure to perform can be reasonably expected to cause the failure of the life support device or to affect its safety or effectiveness.

Customers represent that they have all necessary expertise in the safety and regulatory ramifications of their life support devices or systems, and acknowledge and agree that they are solely responsible for all legal, regulatory and safety-related requirements concerning their products and any use of Diodes Incorporated products in such safety-critical, life support devices or systems, notwithstanding any devices- or systems-related information or support that may be provided by Diodes Incorporated. Further, Customers must fully indemnify Diodes Incorporated and its representatives against any damages arising out of the use of Diodes Incorporated products in such safety-critical, life support devices or systems.

Copyright © 2012, Diodes Incorporated

[www.diodes.com](http://www.diodes.com)