

Trench Gate Power MOSFET

IXTA50N25T IXTH50N25T
IXTP50N25T IXTQ50N25T

$V_{DSS} = 250V$
 $I_{D25} = 50A$
 $R_{DS(on)} \leq 50m\Omega$

N-Channel Enhancement Mode

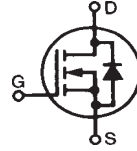

TO-263 (IXTA)

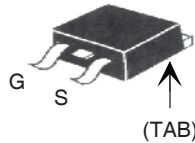

TO-247 (IXTH)

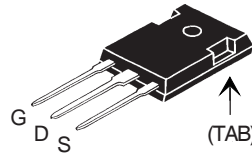

TO-220 (IXTP)

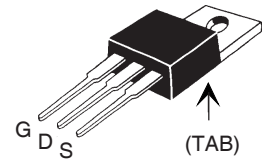

| Symbol | Test Conditions | Maximum Ratings | |
|---------------|---|--------------------|------------|
| V_{DSS} | $T_J = 25^\circ C$ to $150^\circ C$ | 250 | V |
| V_{DGR} | $T_J = 25^\circ C$ to $150^\circ C$, $R_{GS} = 1M\Omega$ | 250 | V |
| V_{GSM} | Transient | ± 30 | V |
| I_{D25} | $T_C = 25^\circ C$ | 50 | A |
| I_{DM} | $T_C = 25^\circ C$, pulse width limited by T_{JM} | 130 | A |
| I_{AS} | $T_C = 25^\circ C$ | 5 | A |
| E_{AS} | $T_C = 25^\circ C$ | 1.5 | J |
| P_D | $T_C = 25^\circ C$ | 400 | W |
| T_J | | -55 ... +150 | $^\circ C$ |
| T_{JM} | | 150 | $^\circ C$ |
| T_{stg} | | -55 ... +150 | $^\circ C$ |
| T_L | 1.6mm (0.062in.) from case for 10s | 300 | $^\circ C$ |
| | Plastic body for 10 seconds | 260 | $^\circ C$ |
| M_d | Mounting Torque TO-220,TO-3P,TO247 | 1.13 / 10 | Nmlb.in. |
| F_c | Mounting Force TO-263 | 10..65 / 2.2..14.6 | N/lb. |
| Weight | TO-263 | 2.5 | g |
| | TO-220 | 3.0 | g |
| | TO-3P | 5.5 | g |
| | TO-247 | 6.0 | g |

TO-3P (IXTQ)

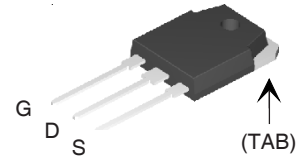

G = Gate D = Drain
S = Source TAB = Drain

Features

- International standard packages
- Avalanche rated
- Low package inductance
 - easy to drive and to protect

Advantages

- Easy to mount
- Space savings
- High power density

Applications

- DC-DC converters
- Battery chargers
- Switched-mode and resonant-mode power supplies
- DC choppers
- AC motor control
- Uninterruptible power supplies
- High speed power switching applications

| Symbol | Test Conditions ($T_J = 25^\circ C$ unless otherwise specified) | Characteristic Values | | |
|--------------|---|-----------------------|-------|---------------|
| | | Min. | Typ . | Max. |
| BV_{DSS} | $V_{GS} = 0V$, $I_D = 1mA$ | 250 | | V |
| $V_{GS(th)}$ | $V_{DS} = V_{GS}$, $I_D = 1mA$ | 3 | | 5 V |
| I_{GSS} | $V_{GS} = \pm 20V$, $V_{DS} = 0V$ | | | ± 100 nA |
| I_{DSS} | $V_{DS} = V_{DSS}$ | | | 1 μA |
| | $V_{GS} = 0V$ $T_J = 125^\circ C$ | | | 150 μA |
| $R_{DS(on)}$ | $V_{GS} = 10V$, $I_D = 0.5 \cdot I_{D25}$, Note 1 | | | 50 m Ω |

| Symbol | Test Conditions ($T_J = 25^\circ\text{C}$ unless otherwise specified) | Characteristic Values | | |
|--------------|--|-----------------------|------|--------------------|
| | | Min. | Typ. | Max. |
| g_{fs} | $V_{DS} = 10\text{V}, I_D = 0.5 \cdot I_{D25}$, Note 1 | 35 | 58 | S |
| C_{iss} | $V_{GS} = 0\text{V}, V_{DS} = 25\text{V}, f = 1\text{MHz}$ | | 4000 | pF |
| C_{oss} | | | 410 | pF |
| C_{rss} | | | 60 | pF |
| $t_{d(on)}$ | Resistive Switching Times $V_{GS} = 15\text{V}, V_{DS} = 0.5 \cdot V_{DSS}, I_D = 0.5 \cdot I_{D25}$ $R_G = 3.3\Omega$ (External) | | 14 | ns |
| t_r | | | 25 | ns |
| $t_{d(off)}$ | | | 47 | ns |
| t_f | | | 25 | ns |
| $Q_{g(on)}$ | $V_{GS} = 10\text{V}, V_{DS} = 0.5 \cdot V_{DSS}, I_D = 0.5 \cdot I_{D25}$ | | 78 | nC |
| Q_{gs} | | | 19 | nC |
| Q_{gd} | | | 22 | nC |
| R_{thJC} | | | 0.31 | $^\circ\text{C/W}$ |
| R_{thCH} | TO-220 | | 0.50 | $^\circ\text{C/W}$ |
| | TO-3P, TO-247 | | 0.25 | $^\circ\text{C/W}$ |

Source-Drain Diode

| Symbol | Test Conditions ($T_J = 25^\circ\text{C}$ unless otherwise specified) | Characteristic Values | | |
|----------|---|-----------------------|------|---------------|
| | | Min. | Typ. | Max. |
| I_S | $V_{GS} = 0\text{V}$ | | | 50 A |
| I_{SM} | Repetitive, pulse width limited by T_{JM} | | | 200 A |
| V_{SD} | $I_F = I_S, V_{GS} = 0\text{V}$, Note 1 | | | 1.5 V |
| t_{rr} | $I_F = 25\text{A}, -di/dt = 250\text{A}/\mu\text{s}$ $V_R = 100\text{V}, V_{GS} = 0\text{V}$ | | 166 | ns |
| I_{RM} | | | 23 | A |
| Q_{RM} | | | 1.9 | μC |

Notes: 1: Pulse test, $t \leq 300\mu\text{s}$; duty cycle, $d \leq 2\%$.

PRELIMINARY TECHNICAL INFORMATION

The product presented herein is under development. The Technical Specifications offered are derived from data gathered during objective characterizations of preliminary engineering lots; but also may yet contain some information supplied during a pre-production design evaluation. IXYS reserves the right to change limits, test conditions, and dimensions without notice.

IXYS reserves the right to change limits, test conditions, and dimensions.

TO-263 (IXTA) Outline

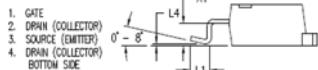
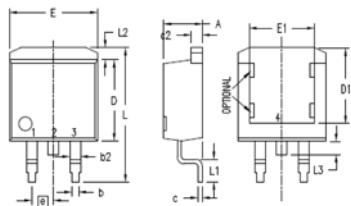

- 1. GATE
 - 2. DRAIN (COLLECTOR)
 - 3. SOURCE (EMITTER)
 - 4. DRAIN (COLLECTOR)
- BOTTOM SIDE

| SYM | INCHES | | MILLIMETERS | |
|-----|----------|------|-------------|-------|
| | MIN | MAX | MIN | MAX |
| A | .160 | .190 | 4.06 | 4.83 |
| A1 | .080 | .110 | 2.03 | 2.79 |
| b | .020 | .039 | 0.51 | 0.99 |
| b2 | .045 | .055 | 1.14 | 1.40 |
| c | .016 | .029 | 0.40 | 0.74 |
| c2 | .045 | .055 | 1.14 | 1.40 |
| D | .340 | .380 | 8.64 | 9.65 |
| D1 | .315 | .350 | 8.00 | 8.89 |
| E | .380 | .410 | 9.65 | 10.41 |
| E1 | .245 | .320 | 6.22 | 8.13 |
| e | .100 BSC | | 2.54 BSC | |
| L | .575 | .625 | 14.61 | 15.88 |
| L1 | .090 | .110 | 2.29 | 2.79 |
| L2 | .040 | .055 | 1.02 | 1.40 |
| L3 | .050 | .070 | 1.27 | 1.78 |
| L4 | 0 | .005 | 0 | 0.13 |

TO-220 (IXTP) Outline

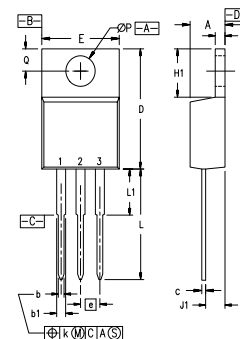

- Pins: 1 - Gate
- 2 - Drain
- 3 - Source
- 4 - Drain

| SYM | INCHES | | MILLIMETERS | |
|-----|----------|------|-------------|-------|
| | MIN | MAX | MIN | MAX |
| A | .170 | .190 | 4.32 | 4.83 |
| b | .025 | .040 | 0.64 | 1.02 |
| b1 | .045 | .065 | 1.15 | 1.65 |
| b2 | .014 | .022 | 0.35 | 0.56 |
| D | .580 | .630 | 14.73 | 16.00 |
| E | .390 | .420 | 9.91 | 10.66 |
| e | .100 BSC | | 2.54 BSC | |
| F | .045 | .055 | 1.14 | 1.40 |
| H1 | .230 | .270 | 5.85 | 6.85 |
| J1 | .090 | .110 | 2.29 | 2.79 |
| k | 0 | .015 | 0 | 0.38 |
| L | .500 | .550 | 12.70 | 13.97 |
| L1 | .110 | .230 | 2.79 | 5.84 |
| ØP | .139 | .161 | 3.53 | 4.08 |
| Q | .100 | .125 | 2.54 | 3.18 |

TO-247 (IXTH) Outline

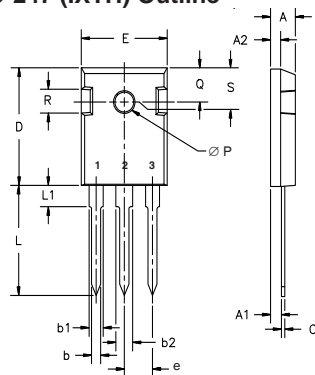

- Terminals: 1 - Gate
- 2 - Drain
- 3 - Source
- Tab - Drain

| Dim. | Millimeter | | Inches | |
|----------------|------------|-------|--------|-------|
| | Min. | Max. | Min. | Max. |
| A | 4.7 | 5.3 | .185 | .209 |
| A ₁ | 2.2 | 2.54 | .087 | .102 |
| A ₂ | 2.2 | 2.6 | .059 | .098 |
| b | 1.0 | 1.4 | .040 | .055 |
| b ₁ | 1.65 | 2.13 | .065 | .084 |
| b ₂ | 2.87 | 3.12 | .113 | .123 |
| C | .4 | .8 | .016 | .031 |
| D | 20.80 | 21.46 | .819 | .845 |
| E | 15.75 | 16.26 | .610 | .640 |
| e | 5.20 | 5.72 | 0.205 | 0.225 |
| L | 19.81 | 20.32 | .780 | .800 |
| L1 | | 4.50 | | .177 |
| ØP | 3.55 | 3.65 | .140 | .144 |
| Q | 5.89 | 6.40 | 0.232 | 0.252 |
| R | 4.32 | 5.49 | .170 | .216 |
| S | 6.15 | BSC | 242 | BSC |

TO-3P (IXTQ) Outline

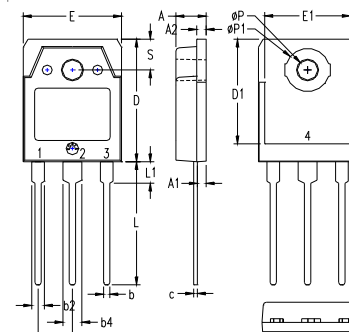

- 1 - GATE
- 2 - DRAIN (COLLECTOR)
- 3 - SOURCE (EMITTER)
- 4 - DRAIN (COLLECTOR)

| SYM | INCHES | | MILLIMETERS | |
|-----|----------|------|-------------|-------|
| | MIN | MAX | MIN | MAX |
| A | .185 | .193 | 4.70 | 4.90 |
| A1 | .051 | .059 | 1.30 | 1.50 |
| A2 | .057 | .065 | 1.45 | 1.65 |
| b | .035 | .045 | 0.90 | 1.15 |
| b2 | .075 | .087 | 1.90 | 2.20 |
| b4 | .114 | .126 | 2.90 | 3.20 |
| c | .022 | .031 | 0.55 | 0.80 |
| D | .780 | .799 | 19.80 | 20.30 |
| D1 | .665 | .677 | 16.90 | 17.20 |
| E | .610 | .622 | 15.50 | 15.80 |
| E1 | .531 | .539 | 13.50 | 13.70 |
| e | .215 BSC | | 5.45 BSC | |
| L | .779 | .795 | 19.80 | 20.20 |
| L1 | .134 | .142 | 3.40 | 3.60 |
| ØP | .126 | .134 | 3.20 | 3.40 |
| ØP1 | .272 | .280 | 6.90 | 7.10 |
| S | .193 | .201 | 4.90 | 5.10 |

Fig. 1. Output Characteristics @ 25°C

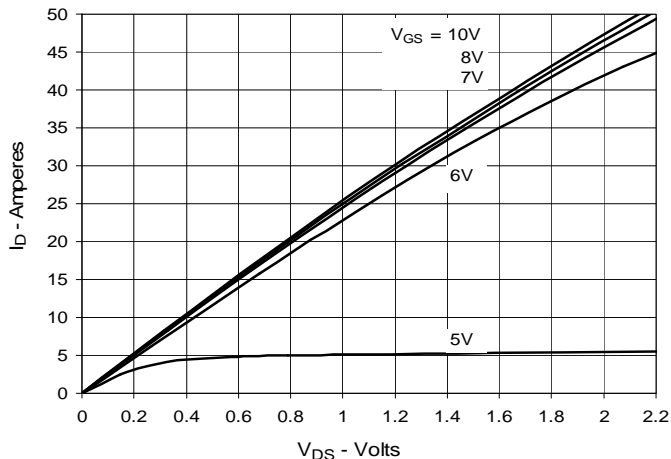

Fig. 2. Extended Output Characteristics @ 25°C

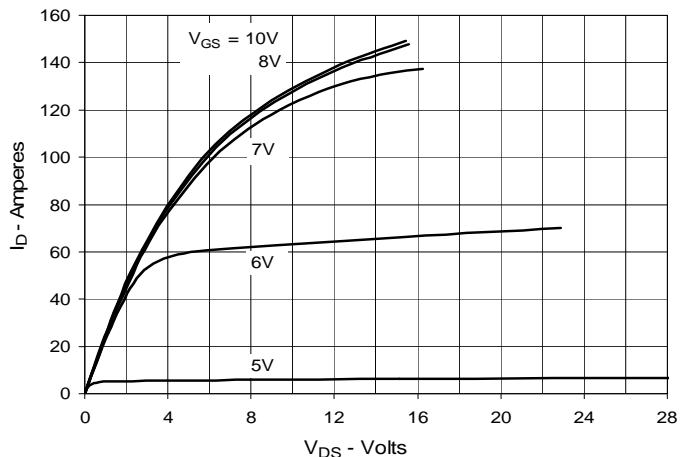

Fig. 3. Output Characteristics @ 125°C

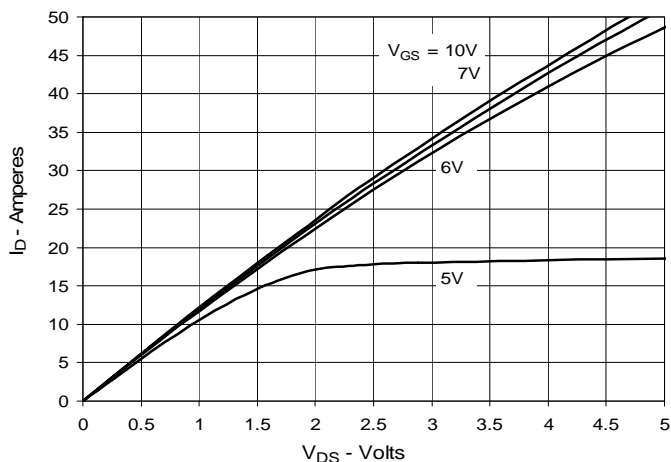

Fig. 4. $R_{DS(on)}$ Normalized to $I_D = 25A$ Value vs. Junction Temperature

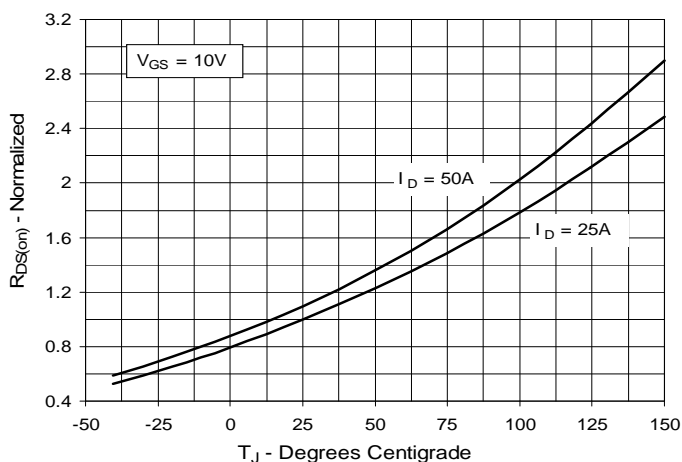

Fig. 5. $R_{DS(on)}$ Normalized to $I_D = 25A$ Value vs. Drain Current

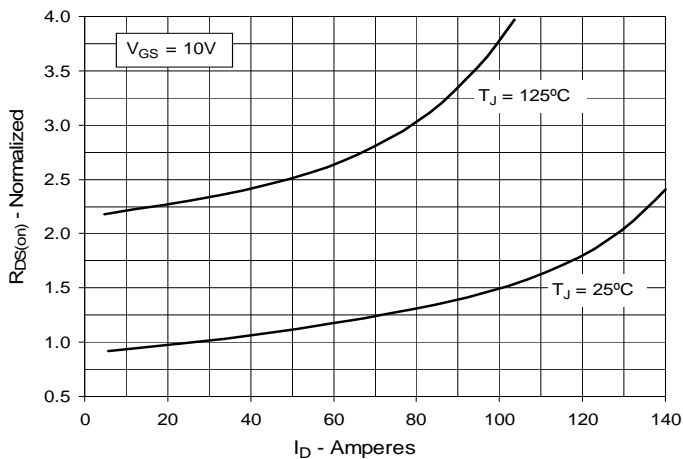

Fig. 6. Maximum Drain Current vs. Case Temperature

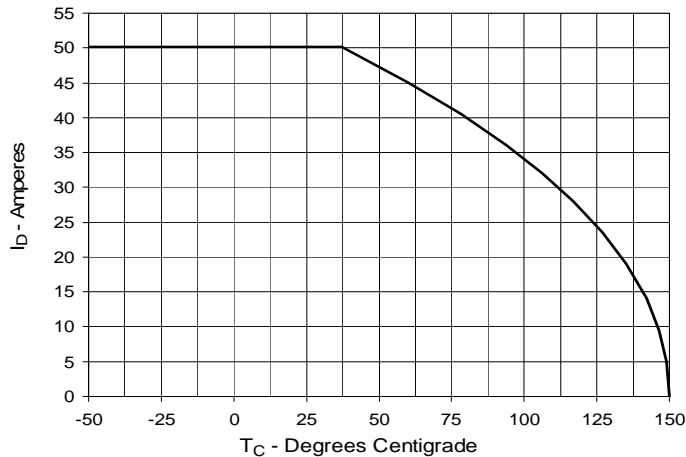

Fig. 7. Input Admittance

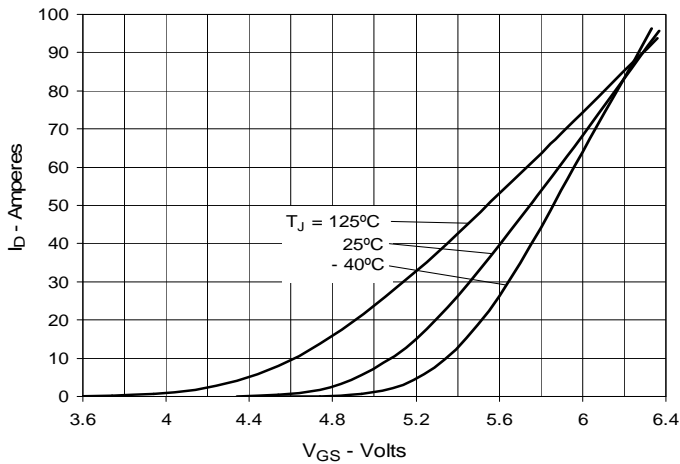

Fig. 8. Transconductance

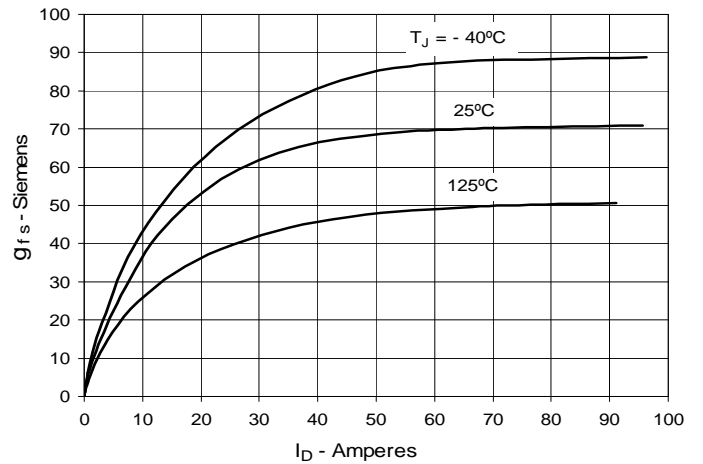

Fig. 9. Forward Voltage Drop of Intrinsic Diode

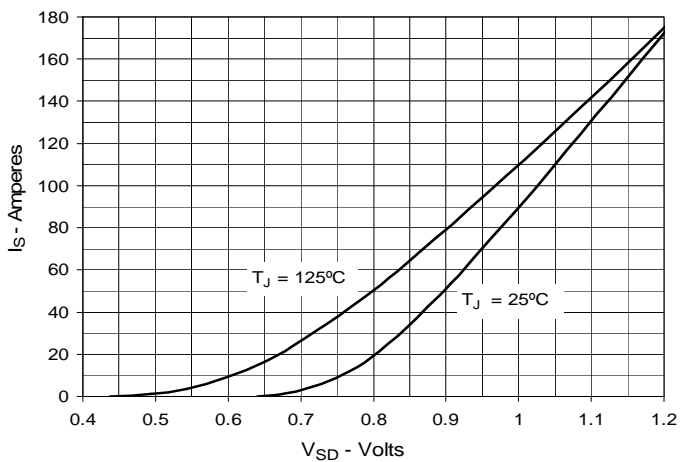

Fig. 10. Gate Charge

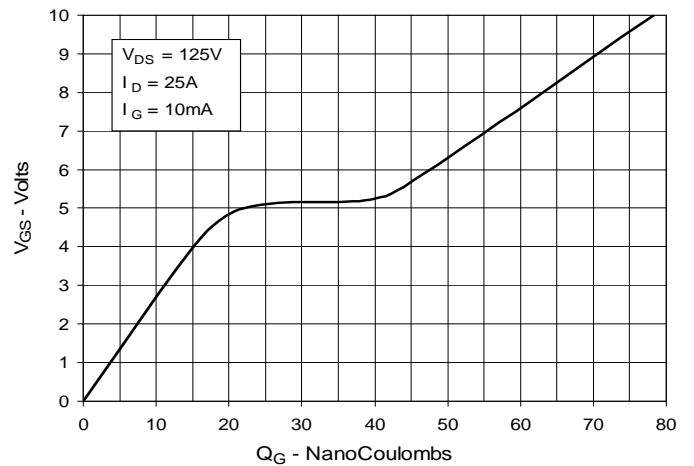

Fig. 11. Capacitance

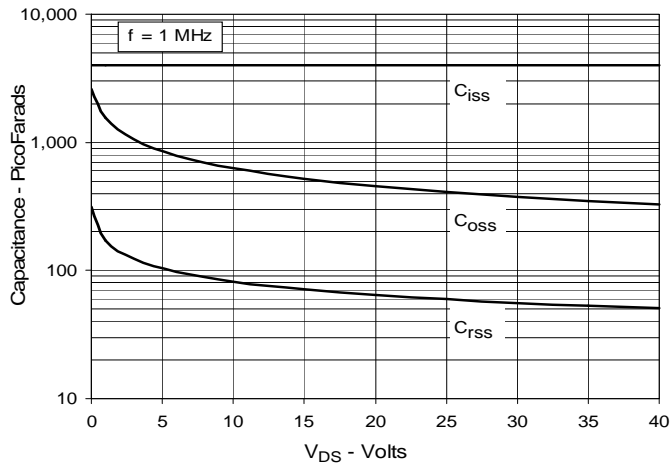
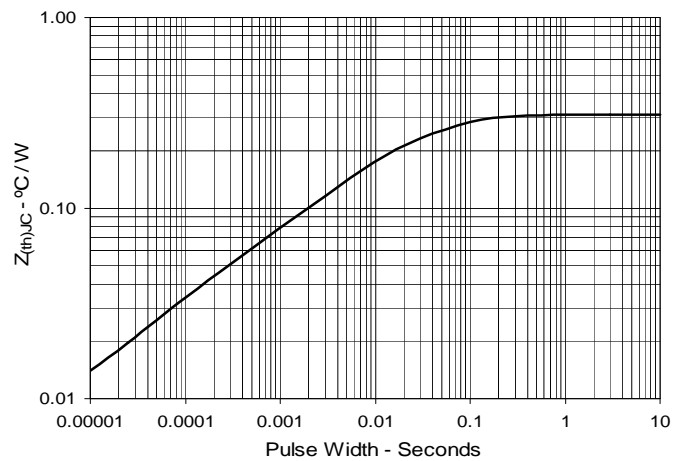
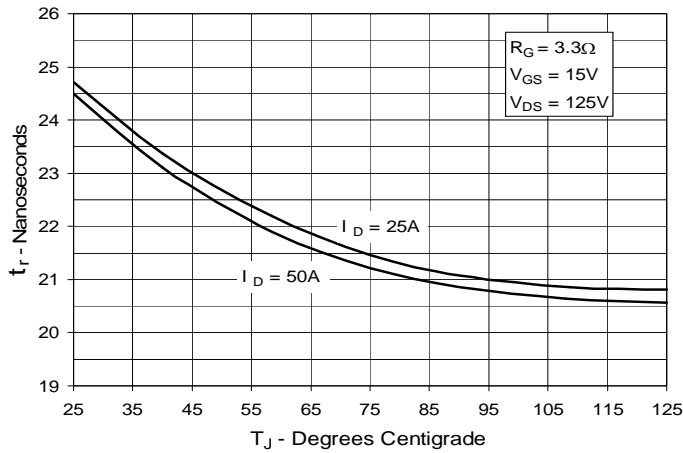

Fig. 12. Maximum Transient Thermal Impedance



**Fig. 13. Resistive Turn-on
Rise Time vs. Junction Temperature**



**Fig. 14. Resistive Turn-on
Rise Time vs. Drain Current**

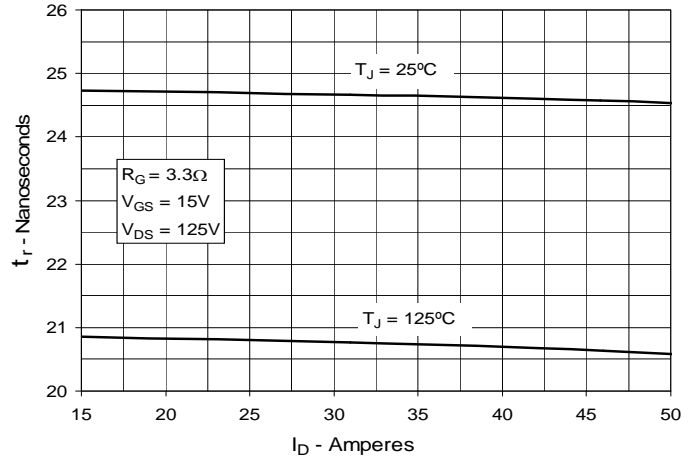

**Fig. 15. Resistive Turn-on
Switching Times vs. Gate Resistance**

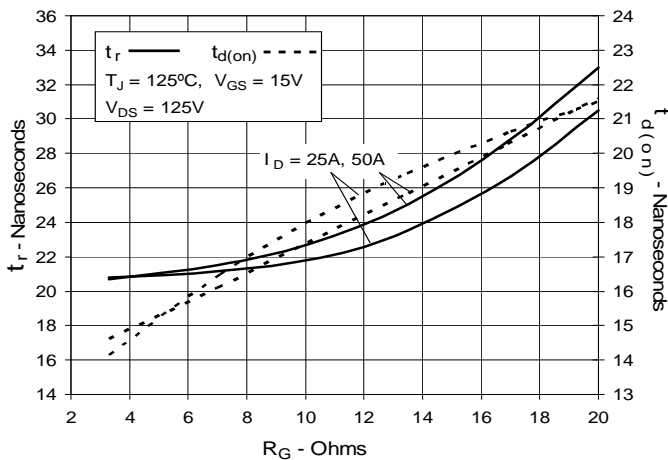

**Fig. 16. Resistive Turn-off
Switching Times vs. Junction Temperature**

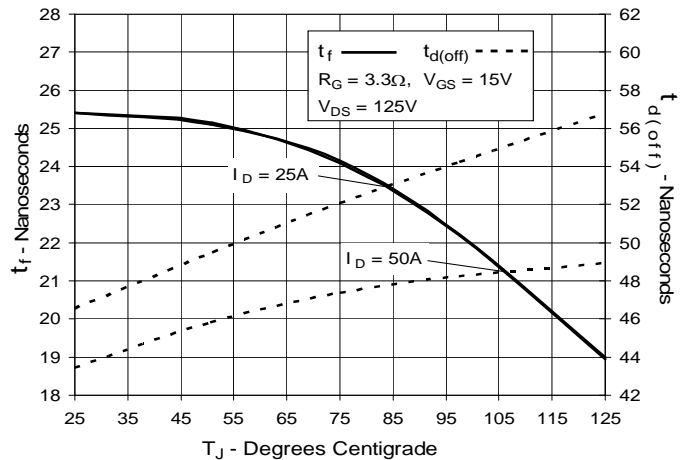

**Fig. 17. Resistive Turn-off
Switching Times vs. Drain Current**

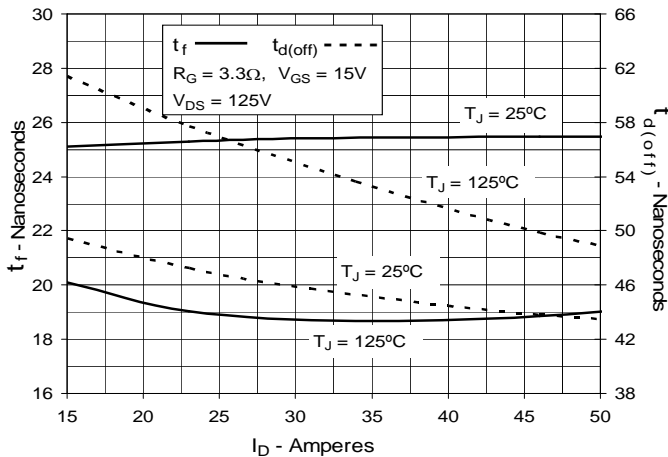

**Fig. 18. Resistive Turn-off
Switching Times vs. Gate Resistance**

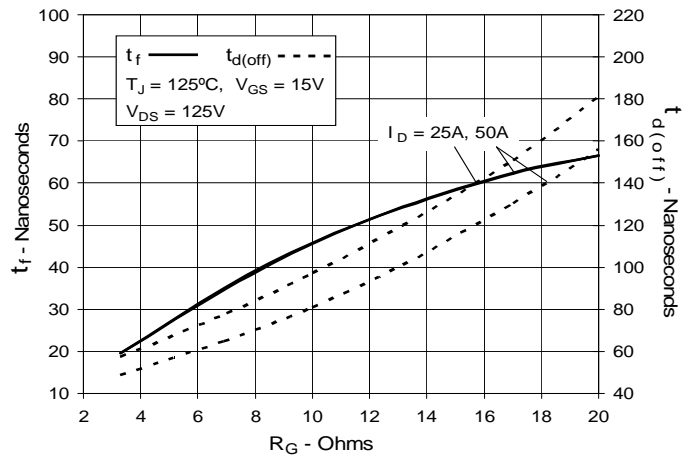

IXYS reserves the right to change limits, test conditions, and dimensions.