

# IRFP4368PbF

## Applications

- High Efficiency Synchronous Rectification in SMPS
- Uninterruptible Power Supply
- High Speed Power Switching
- Hard Switched and High Frequency Circuits

## Benefits

- Improved Gate, Avalanche and Dynamic dv/dt Ruggedness
- Fully Characterized Capacitance and Avalanche SOA
- Enhanced body diode dV/dt and dI/dt Capability

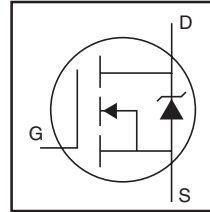

HEXFET® Power MOSFET

$V_{DSS}$	<b>75V</b>
$R_{DS(on)}$ <b>typ.</b>	<b>1.46mΩ</b>
	<b>max.</b>
$I_D$ (Silicon Limited)	<b>350A</b> ①
$I_D$ (Package Limited)	<b>195A</b>

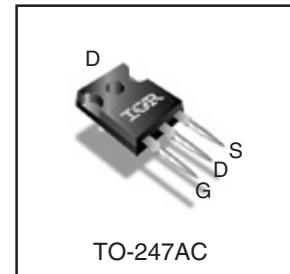

<b>G</b>	<b>D</b>	<b>S</b>
Gate	Drain	Source

## Absolute Maximum Ratings

Symbol	Parameter	Max.	Units
$I_D$ @ $T_C = 25^\circ\text{C}$	Continuous Drain Current, $V_{GS}$ @ 10V (Silicon Limited)	350①	A
$I_D$ @ $T_C = 100^\circ\text{C}$	Continuous Drain Current, $V_{GS}$ @ 10V (Silicon Limited)	250①	
$I_D$ @ $T_C = 25^\circ\text{C}$	Continuous Drain Current, $V_{GS}$ @ 10V (Wire Bond Limited)	195	
$I_{DM}$	Pulsed Drain Current ②	1280	
$P_D$ @ $T_C = 25^\circ\text{C}$	Maximum Power Dissipation	520	W
	Linear Derating Factor	3.4	W/°C
$V_{GS}$	Gate-to-Source Voltage	± 20	V
dv/dt	Peak Diode Recovery ④	13	V/ns
$T_J$	Operating Junction and	-55 to + 175	°C
$T_{STG}$	Storage Temperature Range		
	Soldering Temperature, for 10 seconds (1.6mm from case)		
	Mounting torque, 6-32 or M3 screw	10lb·in (1.1N·m)	

## Avalanche Characteristics

$E_{AS}$ (Thermally limited)	Single Pulse Avalanche Energy ③	430	mJ
$I_{AR}$	Avalanche Current ②	See Fig. 14, 15, 22a, 22b	A
$E_{AR}$	Repetitive Avalanche Energy ⑤		mJ

## Thermal Resistance

Symbol	Parameter	Typ.	Max.	Units
$R_{\theta JC}$	Junction-to-Case ⑥	—	0.29	°C/W
$R_{\theta CS}$	Case-to-Sink, Flat Greased Surface	0.24	—	
$R_{\theta JA}$	Junction-to-Ambient ⑥⑦	—	40	

**Static @ T<sub>J</sub> = 25°C (unless otherwise specified)**

Symbol	Parameter	Min.	Typ.	Max.	Units	Conditions
V <sub>(BR)DSS</sub>	Drain-to-Source Breakdown Voltage	75	—	—	V	V <sub>GS</sub> = 0V, I <sub>D</sub> = 250μA
ΔV <sub>(BR)DSS/ΔT<sub>J</sub></sub>	Breakdown Voltage Temp. Coefficient	—	0.077	—	V/°C	Reference to 25°C, I <sub>D</sub> = 5mA <sup>②</sup>
R <sub>DS(on)</sub>	Static Drain-to-Source On-Resistance	—	1.46	1.85	mΩ	V <sub>GS</sub> = 10V, I <sub>D</sub> = 195A <sup>③</sup>
V <sub>GS(th)</sub>	Gate Threshold Voltage	2.0	—	4.0	V	V <sub>DS</sub> = V <sub>GS</sub> , I <sub>D</sub> = 250μA
I <sub>DSS</sub>	Drain-to-Source Leakage Current	—	—	20	μA	V <sub>DS</sub> = 75V, V <sub>GS</sub> = 0V
		—	—	250		V <sub>DS</sub> = 75V, V <sub>GS</sub> = 0V, T <sub>J</sub> = 125°C
I <sub>GSS</sub>	Gate-to-Source Forward Leakage	—	—	100	nA	V <sub>GS</sub> = 20V
	Gate-to-Source Reverse Leakage	—	—	-100		V <sub>GS</sub> = -20V

**Dynamic @ T<sub>J</sub> = 25°C (unless otherwise specified)**

Symbol	Parameter	Min.	Typ.	Max.	Units	Conditions
gfs	Forward Transconductance	650	—	—	S	V <sub>DS</sub> = 50V, I <sub>D</sub> = 195A
Q <sub>g</sub>	Total Gate Charge	—	380	570	nC	I <sub>D</sub> = 195A
Q <sub>gs</sub>	Gate-to-Source Charge	—	79	—		V <sub>DS</sub> = 38V
Q <sub>gd</sub>	Gate-to-Drain ("Miller") Charge	—	105	—		V <sub>GS</sub> = 10V <sup>⑤</sup>
Q <sub>sync</sub>	Total Gate Charge Sync. (Q <sub>g</sub> - Q <sub>gd</sub> )	—	275	—		I <sub>D</sub> = 195A, V <sub>DS</sub> = 0V, V <sub>GS</sub> = 10V
R <sub>G(int)</sub>	Internal Gate Resistance	—	0.80	—	Ω	
t <sub>d(on)</sub>	Turn-On Delay Time	—	43	—	ns	V <sub>DD</sub> = 49V
t <sub>r</sub>	Rise Time	—	220	—		I <sub>D</sub> = 195A
t <sub>d(off)</sub>	Turn-Off Delay Time	—	170	—		R <sub>G</sub> = 2.7Ω
t <sub>f</sub>	Fall Time	—	260	—		V <sub>GS</sub> = 10V <sup>⑤</sup>
C <sub>iss</sub>	Input Capacitance	—	19230	—	pF	V <sub>GS</sub> = 0V
C <sub>oss</sub>	Output Capacitance	—	1670	—		V <sub>DS</sub> = 50V
C <sub>rss</sub>	Reverse Transfer Capacitance	—	770	—		f = 100kHz
C <sub>oss</sub> eff. (ER)	Effective Output Capacitance (Energy Related) <sup>⑦</sup>	—	1700	—		V <sub>GS</sub> = 0V, V <sub>DS</sub> = 0V to 60V <sup>⑦</sup>
C <sub>oss</sub> eff. (TR)	Effective Output Capacitance (Time Related) <sup>⑧</sup>	—	1410	—		V <sub>GS</sub> = 0V, V <sub>DS</sub> = 0V to 60V <sup>⑧</sup>

**Diode Characteristics**

Symbol	Parameter	Min.	Typ.	Max.	Units	Conditions
I <sub>S</sub>	Continuous Source Current (Body Diode)	—	—	350 <sup>①</sup>	A	MOSFET symbol showing the integral reverse p-n junction diode.
I <sub>SM</sub>	Pulsed Source Current (Body Diode) <sup>②⑦</sup>	—	—	1280		
V <sub>SD</sub>	Diode Forward Voltage	—	—	1.3	V	T <sub>J</sub> = 25°C, I <sub>S</sub> = 195A, V <sub>GS</sub> = 0V <sup>⑤</sup>
t <sub>rr</sub>	Reverse Recovery Time	—	130	200	ns	T <sub>J</sub> = 25°C V <sub>R</sub> = 64V,
		—	140	210		T <sub>J</sub> = 125°C I <sub>F</sub> = 195A
Q <sub>rr</sub>	Reverse Recovery Charge	—	450	680	nC	T <sub>J</sub> = 25°C di/dt = 100A/μs <sup>⑤</sup>
		—	530	800		T <sub>J</sub> = 125°C
I <sub>RRM</sub>	Reverse Recovery Current	—	9.1	—	A	T <sub>J</sub> = 25°C
t <sub>on</sub>	Forward Turn-On Time	Intrinsic turn-on time is negligible (turn-on is dominated by LS+LD)				

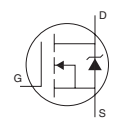

**Notes:**

- ① Calculated continuous current based on maximum allowable junction temperature. Bond wire current limit is 195A. Note that current limitations arising from heating of the device leads may occur with some lead mounting arrangements. Refer to App Notes (AN-1140).
- ② Repetitive rating; pulse width limited by max. junction temperature.
- ③ Limited by T<sub>Jmax</sub>, starting T<sub>J</sub> = 25°C, L = 0.022mH  
R<sub>G</sub> = 25Ω, I<sub>AS</sub> = 195A, V<sub>GS</sub> = 10V. Part not recommended for use above this value.
- ④ I<sub>SD</sub> ≤ 195A, di/dt ≤ 1740A/μs, V<sub>DD</sub> ≤ V<sub>(BR)DSS</sub>, T<sub>J</sub> ≤ 175°C.
- ⑤ Pulse width ≤ 400μs; duty cycle ≤ 2%.
- ⑥ C<sub>oss</sub> eff. (TR) is a fixed capacitance that gives the same charging time as C<sub>oss</sub> while V<sub>DS</sub> is rising from 0 to 80% V<sub>DSS</sub>.
- ⑦ C<sub>oss</sub> eff. (ER) is a fixed capacitance that gives the same energy as C<sub>oss</sub> while V<sub>DS</sub> is rising from 0 to 80% V<sub>DSS</sub>.
- ⑧ When mounted on 1" square PCB (FR-4 or G-10 Material). For recommended footprint and soldering techniques refer to application note #AN-994.
- ⑨ R<sub>θjθ</sub> is measured at T<sub>J</sub> approximately 90°C.

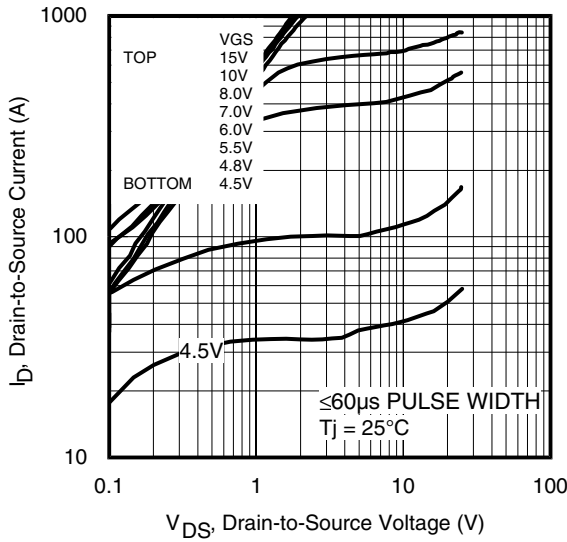

Fig 1. Typical Output Characteristics

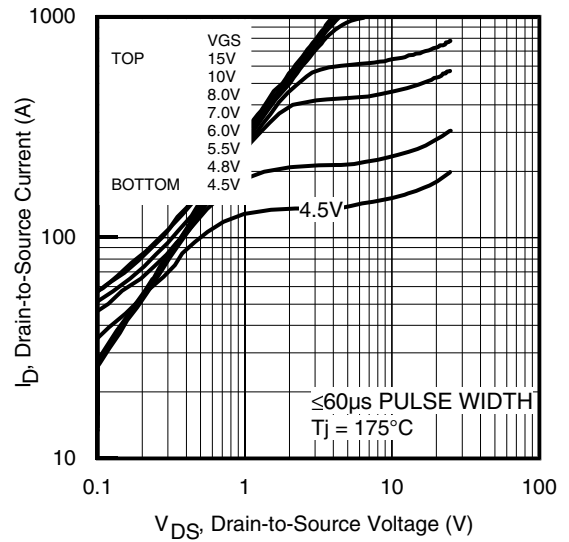

Fig 2. Typical Output Characteristics

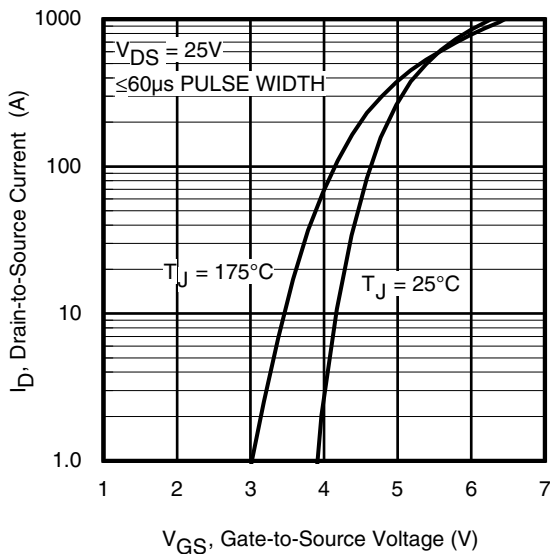

Fig 3. Typical Transfer Characteristics

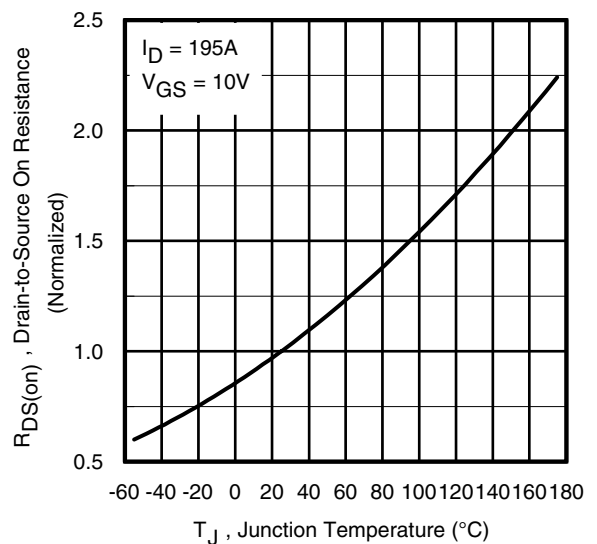

Fig 4. Normalized On-Resistance vs. Temperature

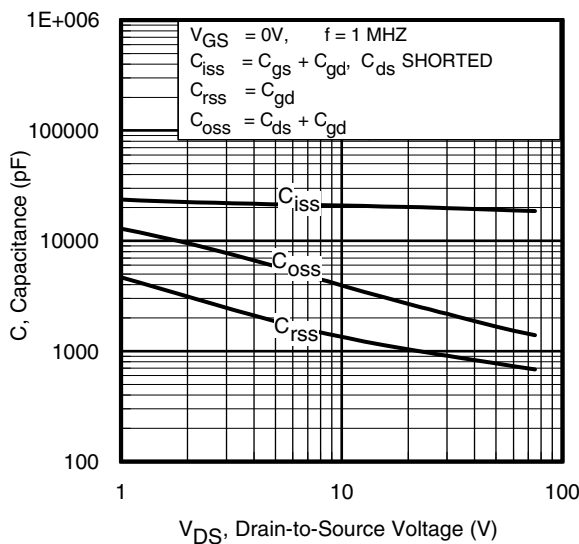

Fig 5. Typical Capacitance vs. Drain-to-Source Voltage

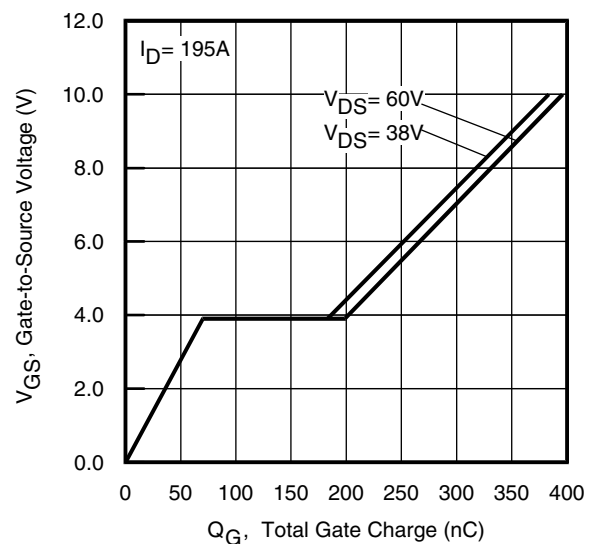

Fig 6. Typical Gate Charge vs. Gate-to-Source Voltage

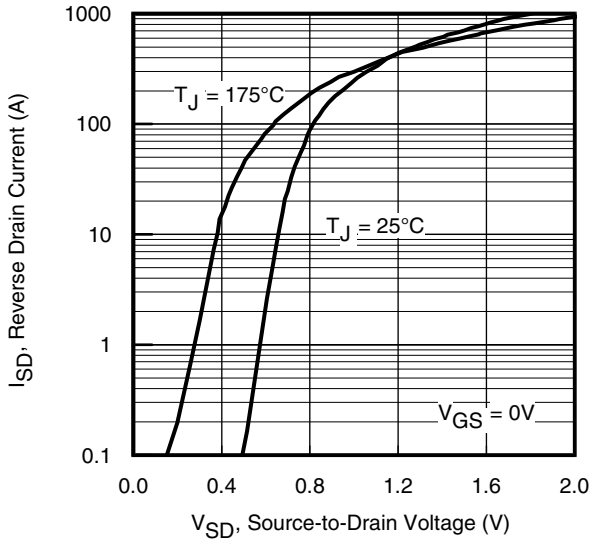

Fig 7. Typical Source-Drain Diode Forward Voltage

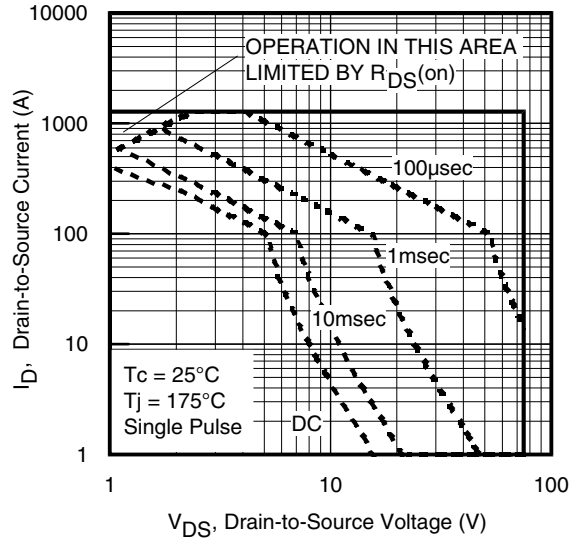

Fig 8. Maximum Safe Operating Area

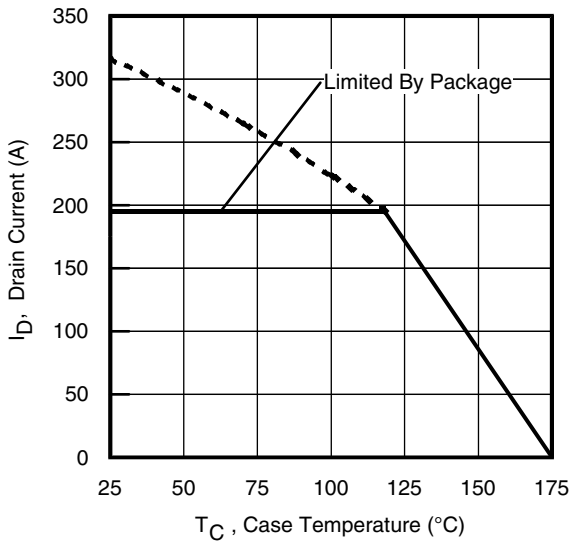

Fig 9. Maximum Drain Current vs. Case Temperature

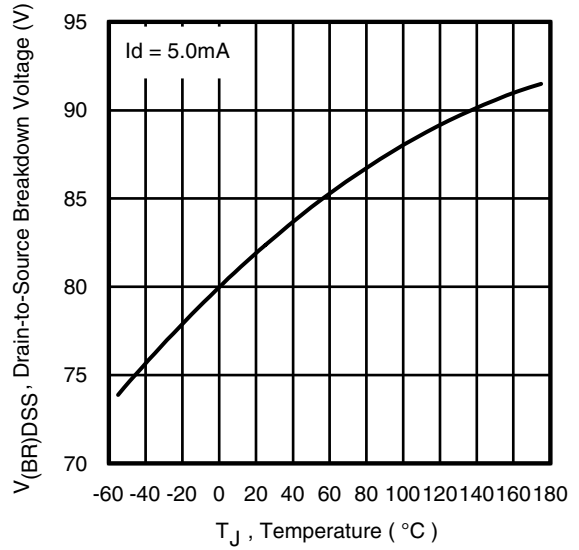

Fig 10. Drain-to-Source Breakdown Voltage

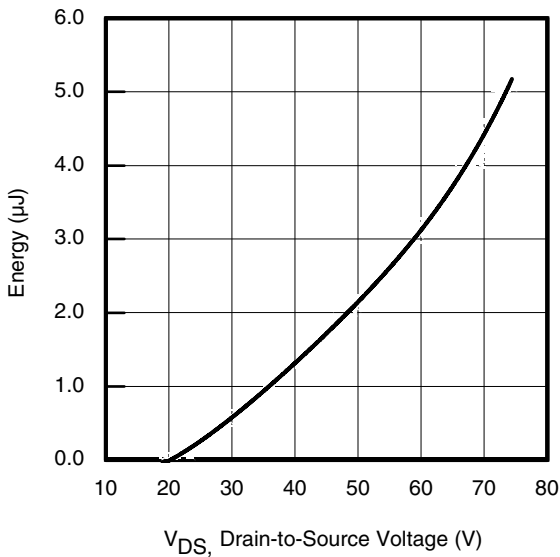

Fig 11. Typical C<sub>OSS</sub> Stored Energy

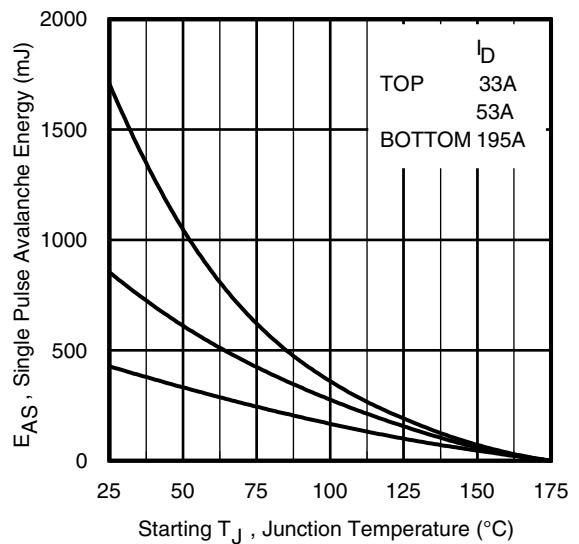

Fig 12. Maximum Avalanche Energy vs. Drain Current  
www.irf.com

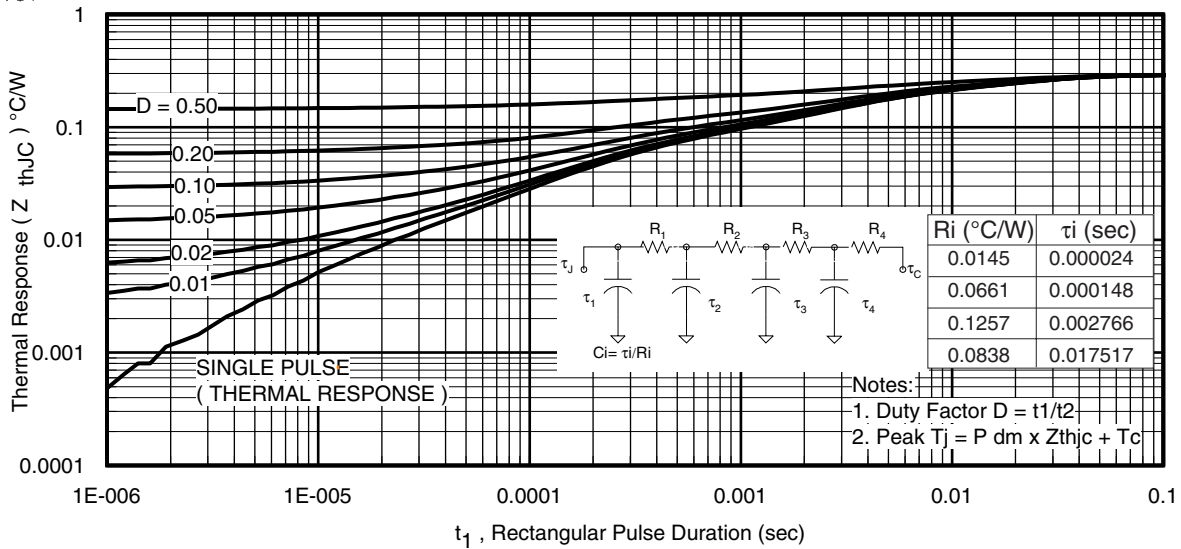

Fig 13. Maximum Effective Transient Thermal Impedance, Junction-to-Case

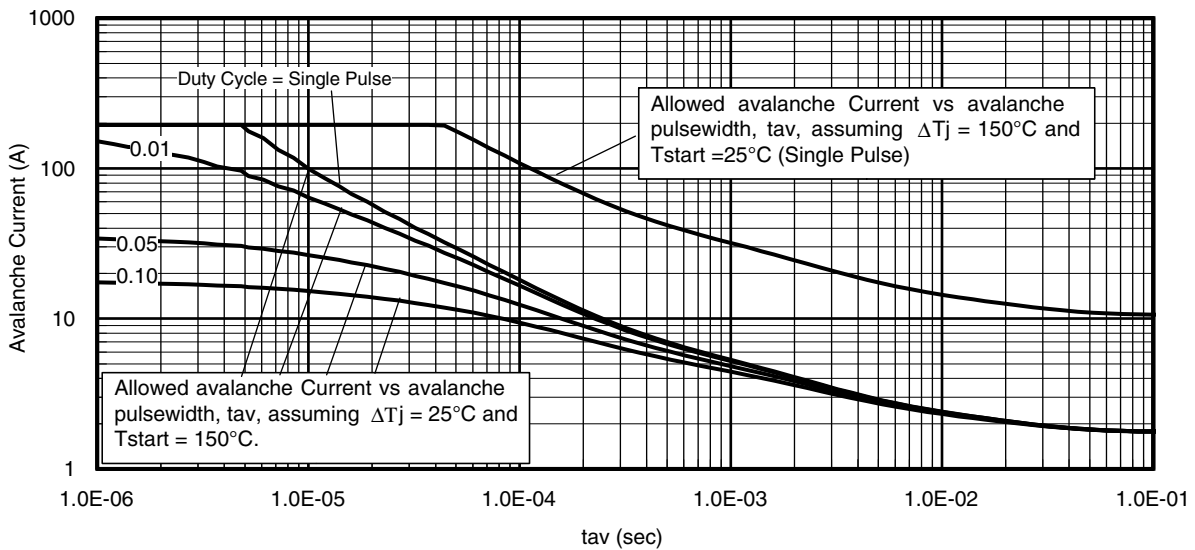

Fig 14. Typical Avalanche Current vs. Pulsewidth

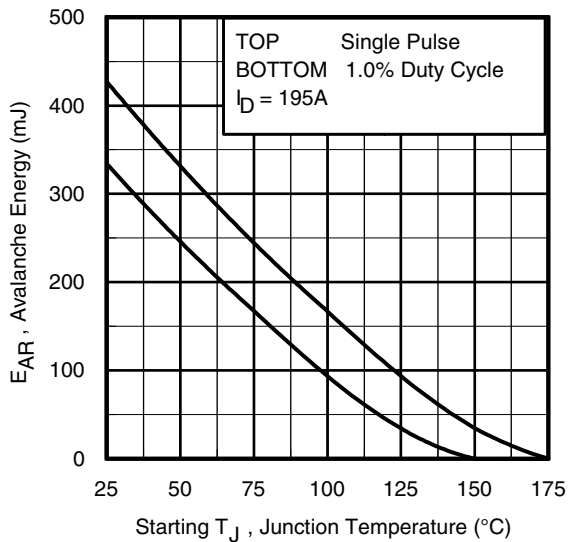

Fig 15. Maximum Avalanche Energy vs. Temperature

**Notes on Repetitive Avalanche Curves , Figures 14, 15:**  
(For further info, see AN-1005 at [www.irf.com](http://www.irf.com))

1. Avalanche failures assumption:  
Purely a thermal phenomenon and failure occurs at a temperature far in excess of  $T_{jmax}$ . This is validated for every part type.
2. Safe operation in Avalanche is allowed as long as  $T_{jmax}$  is not exceeded.
3. Equation below based on circuit and waveforms shown in Figures 16a, 16b.
4.  $P_{D(ave)}$  = Average power dissipation per single avalanche pulse.
5. BV = Rated breakdown voltage (1.3 factor accounts for voltage increase during avalanche).
6.  $I_{av}$  = Allowable avalanche current.
7.  $\Delta T$  = Allowable rise in junction temperature, not to exceed  $T_{jmax}$  (assumed as 25°C in Figure 14, 15).  
 $t_{av}$  = Average time in avalanche.  
 $D$  = Duty cycle in avalanche =  $t_{av} \cdot f$   
 $Z_{thJC}(D, t_{av})$  = Transient thermal resistance, see Figures 13)

$$P_{D(ave)} = 1/2 ( 1.3 \cdot BV \cdot I_{av} ) = \Delta T / Z_{thJC}$$

$$I_{av} = 2\Delta T / [1.3 \cdot BV \cdot Z_{th}]$$

$$E_{AS(AR)} = P_{D(ave)} \cdot t_{av}$$

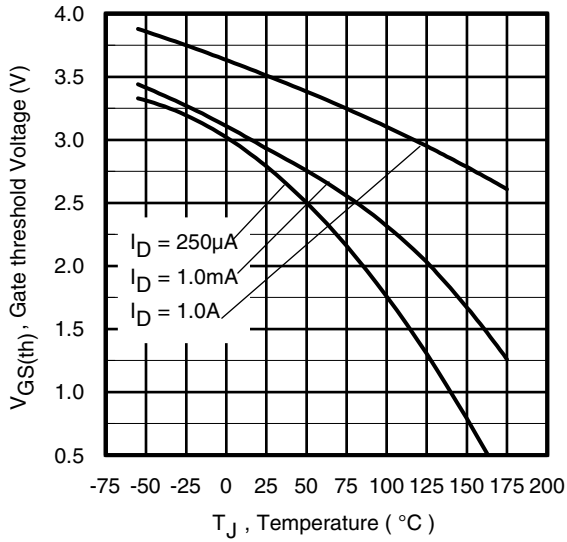

Fig 16. Threshold Voltage vs. Temperature

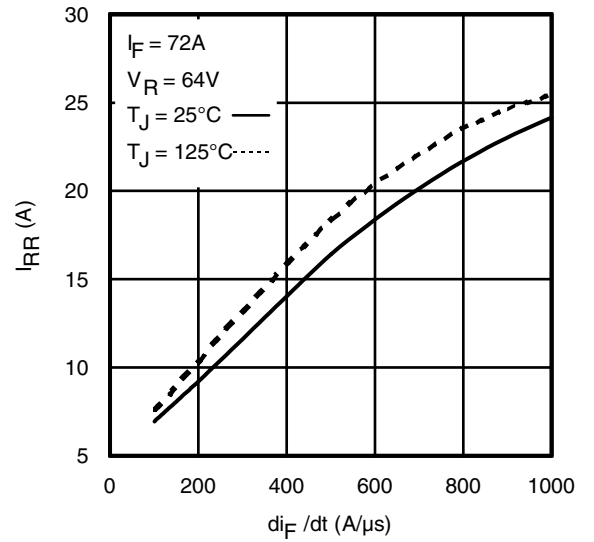

Fig. 17 - Typical Recovery Current vs.  $di_f/dt$

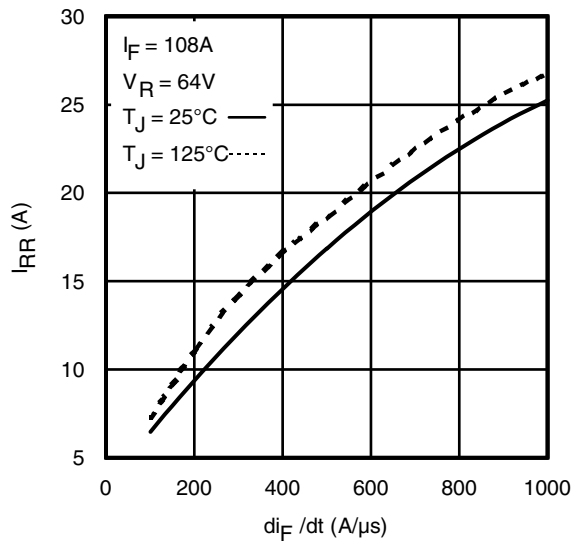

Fig. 18 - Typical Recovery Current vs.  $di_f/dt$

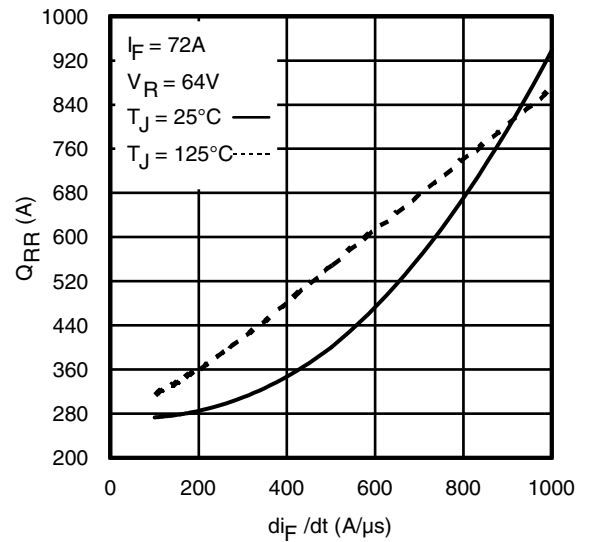

Fig. 19 - Typical Stored Charge vs.  $di_f/dt$

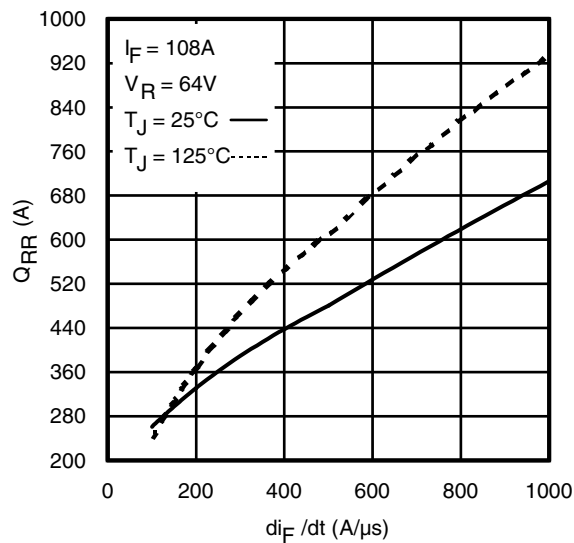
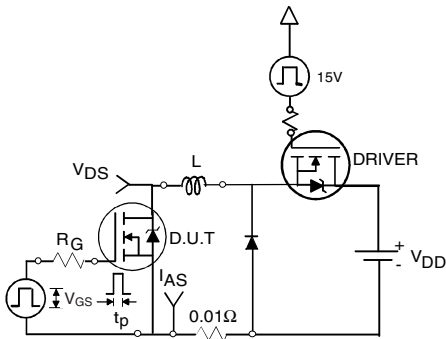

Fig. 20 - Typical Stored Charge vs.  $di_f/dt$



\*  $V_{GS} = 5V$  for Logic Level Devices

**Fig 20. Peak Diode Recovery  $dv/dt$  Test Circuit for N-Channel HEXFET<sup>®</sup> Power MOSFETs**



**Fig 21a. Unclamped Inductive Test Circuit**



**Fig 21b. Unclamped Inductive Waveforms**

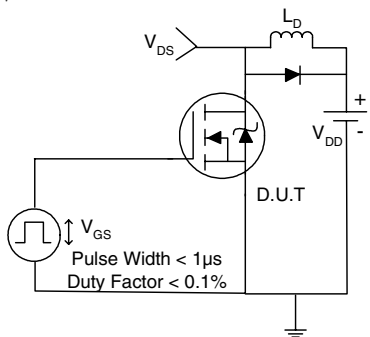

**Fig 22a. Switching Time Test Circuit**



**Fig 22b. Switching Time Waveforms**

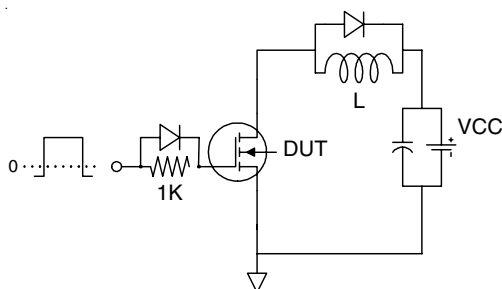

**Fig 23a. Gate Charge Test Circuit**



**Fig 23b. Gate Charge Waveform**

TO-247AC Package Outline

Dimensions are shown in millimeters (inches)

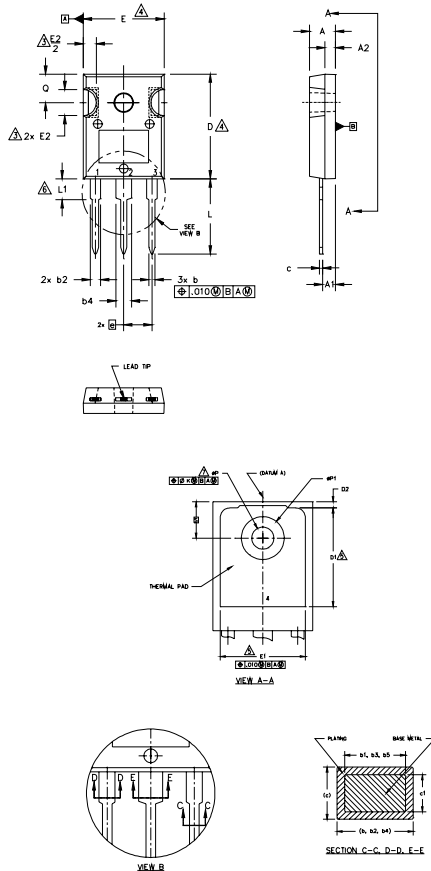

- NOTES:
1. DIMENSIONING AND TOLERANCING AS PER ASME Y14.5M 1994.
  2. DIMENSIONS ARE SHOWN IN INCHES.
  3. CONTOUR OF SLOT OPTIONAL.
  4. DIMENSION D & E DO NOT INCLUDE MOLD FLASH. MOLD FLASH SHALL NOT EXCEED .005" (0.127) PER SIDE. THESE DIMENSIONS ARE MEASURED AT THE OUTERMOST EXTREMES OF THE PLASTIC BODY.
  5. THERMAL PAD CONTOUR OPTIONAL WITHIN DIMENSIONS D1 & E1.
  6. LEAD FINISH UNCONTROLLED IN L1.
  7. ØP TO HAVE A MAXIMUM DRAFT ANGLE OF 1.5 ° TO THE TOP OF THE PART WITH A MAXIMUM HOLE DIAMETER OF .154 INCH.
  8. OUTLINE CONFORMS TO JEDEC OUTLINE TO-247AC .

SYMBOL	DIMENSIONS				NOTES
	INCHES		MILLIMETERS		
	MIN.	MAX.	MIN.	MAX.	
A	.183	.209	4.65	5.31	
A1	.087	.102	2.21	2.59	
A2	.059	.098	1.50	2.49	
b	.039	.055	0.99	1.40	
b1	.039	.053	0.99	1.35	
b2	.065	.094	1.65	2.39	
b3	.065	.092	1.65	2.34	
b4	.102	.135	2.59	3.43	
b5	.102	.133	2.59	3.38	
c	.015	.035	0.38	0.89	
c1	.015	.033	0.38	0.84	
D	.776	.815	19.71	20.70	4
D1	.515	-	13.08	-	5
D2	.020	.053	0.51	1.35	4
E	.602	.625	15.29	15.87	4
E1	.530	-	13.46	-	
E2	.178	.216	4.52	5.49	
e	.215 BSC		5.46 BSC		
Øk	.010		0.25		
L	.559	.634	14.20	16.10	
L1	.146	.169	3.71	4.29	
ØP	.140	.144	3.56	3.66	
ØP1	-	.291	-	7.39	
Q	.209	.224	5.31	5.69	
S	.217 BSC		5.51 BSC		

LEAD ASSIGNMENTS

HEXFET

- 1.- GATE
- 2.- DRAIN
- 3.- SOURCE
- 4.- DRAIN

IGBTs, CoPACK

- 1.- GATE
- 2.- COLLECTOR
- 3.- EMITTER
- 4.- COLLECTOR

DIODES

- 1.- ANODE/OPEN
- 2.- CATHODE
- 3.- ANODE

TO-247AC Part Marking Information

EXAMPLE: THIS IS AN IRFPE30  
WITH ASSEMBLY  
LOT CODE 5657  
ASSEMBLED ON WW 35, 2001  
IN THE ASSEMBLY LINE "H"

Note: "P" in assembly line position  
indicates "Lead-Free"

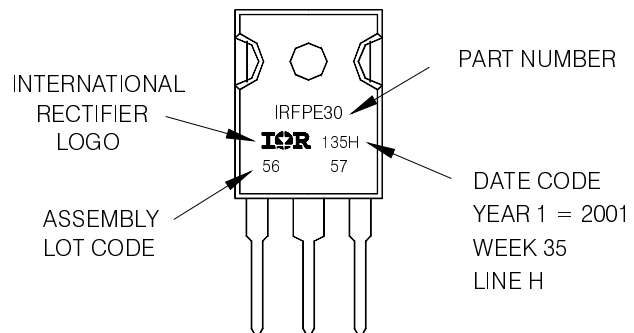

TO-247AC package is not recommended for Surface Mount Application.

Note: For the most current drawing please refer to IR website at <http://www.irf.com/package/>

Data and specifications subject to change without notice.  
This product has been designed and qualified for the Industrial market.  
Qualification Standards can be found on IR's Web site.