

Complementary 20-V (D-S) Low-Threshold MOSFET

PRODUCT SUMMARY			
	V_{DS} (V)	$r_{DS(on)}$ (Ω)	I_D (A)
N-Channel	20	0.280 @ $V_{GS} = 4.5$ V	1.28
		0.360 @ $V_{GS} = 2.5$ V	1.13
		0.450 @ $V_{GS} = 1.8$ V	1.00
P-Channel	-20	0.490 @ $V_{GS} = -4.5$ V	-1.00
		0.750 @ $V_{GS} = -2.5$ V	-0.81
		1.10 @ $V_{GS} = -1.8$ V	-0.67

FEATURES

- TrenchFET® Power MOSFETS: 1.8-V Rated
- ESD Protected: 2000 V
- Thermally Enhanced SC-70 Package

APPLICATIONS

- Load Switching
- PA Switch
- Level Switch

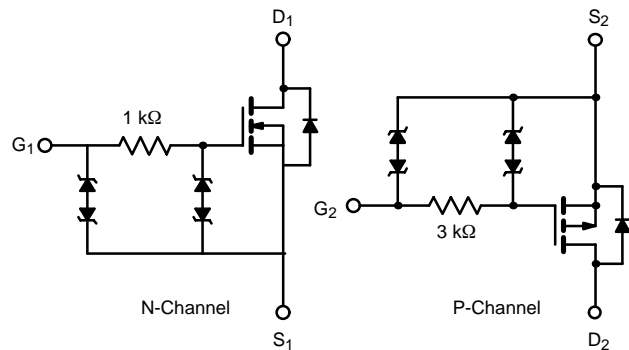
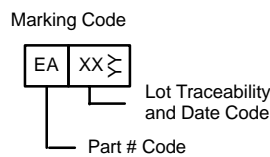
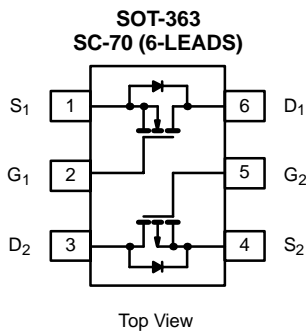

ABSOLUTE MAXIMUM RATINGS ($T_A = 25^\circ\text{C}$ UNLESS OTHERWISE NOTED)

Parameter	Symbol	N-Channel		P-Channel		Unit	
		5 secs	Steady State	5 secs	Steady State		
Drain-Source Voltage	V_{DS}	20		-20		V	
Gate-Source Voltage	V_{GS}	±12		±12			
Continuous Drain Current ($T_J = 150^\circ\text{C}$) ^a	I_D	$T_A = 25^\circ\text{C}$	1.28	1.13	-1.00	-0.88	A
		$T_A = 85^\circ\text{C}$	0.92	0.81	-0.72	-0.63	
Pulsed Drain Current	I_{DM}	4.0		-3.0			
Continuous Source Current (Diode Conduction) ^a	I_S	0.61	0.48	-0.61	-0.48		
Maximum Power Dissipation ^a	P_D	$T_A = 25^\circ\text{C}$	0.74	0.57	0.30	0.57	W
		$T_A = 85^\circ\text{C}$	0.38	0.30	0.16	0.3	
Operating Junction and Storage Temperature Range	T_J, T_{stg}	-55 to 150				$^\circ\text{C}$	

THERMAL RESISTANCE RATINGS

Parameter		Symbol	Typical	Maximum	Unit
Maximum Junction-to-Ambient ^a	$t \leq 5$ sec	R_{thJA}	130	170	$^\circ\text{C/W}$
	Steady State		170	220	
Maximum Junction-to-Foot (Drain)	Steady State	R_{thJF}	80	100	

Notes

a. Surface Mounted on 1" x 1" FR4 Board.

SPECIFICATIONS (T _J = 25 °C UNLESS OTHERWISE NOTED)							
Parameter	Symbol	Test Condition		Min	Typ	Max	Unit
Static							
Gate Threshold Voltage	V _{GS(th)}	V _{DS} = V _{GS} , I _D = 100 μA	N-Ch	0.45			V
		V _{DS} = V _{GS} , I _D = -100 μA	P-Ch	-0.45			
Gate-Body Leakage	I _{GSS}	V _{DS} = 0 V, V _{GS} = ±4.5 V	N-Ch			±1	μA
			P-Ch			±1	
		V _{DS} = 0 V, V _{GS} = ±12 V	N-Ch			±10	mA
			P-Ch			±10	
Zero Gate Voltage Drain Current	I _{DSS}	V _{DS} = 16 V, V _{GS} = 0 V	N-Ch			1	μA
		V _{DS} = -16 V, V _{GS} = 0 V	P-Ch			-1	
		V _{DS} = 16 V, V _{GS} = 0 V, T _J = 85 °C	N-Ch			5	
		V _{DS} = -16 V, V _{GS} = 0 V, T _J = 85 °C	P-Ch			-5	
On-State Drain Current ^a	I _{D(on)}	V _{DS} ≥ 5 V, V _{GS} = 4.5 V	N-Ch	2			A
		V _{DS} ≤ -5 V, V _{GS} = -4.5 V	P-Ch	-2			
Drain-Source On-State Resistance ^a	r _{DS(on)}	V _{GS} = 4.5 V, I _D = 1.13 A	N-Ch		0.220	0.280	Ω
		V _{GS} = -4.5 V, I _D = -0.88 A	P-Ch		0.400	0.490	
		V _{GS} = 2.5 V, I _D = 0.99 A	N-Ch		0.281	0.360	
		V _{GS} = -2.5 V, I _D = -0.71 A	P-Ch		0.610	0.750	
		V _{GS} = 1.8 V, I _D = 0.20 A	N-Ch		0.344	0.450	
		V _{GS} = -1.8 V, I _D = -0.20 A	P-Ch		0.850	1.10	
Forward Transconductance ^a	g _{fs}	V _{DS} = 10 V, I _D = 1.13 A	N-Ch		2.6		S
		V _{DS} = -10 V, I _D = -0.88 A	P-Ch		1.5		
Diode Forward Voltage ^a	V _{SD}	I _S = 0.48 A, V _{GS} = 0 V	N-Ch		0.8	1.2	V
		I _S = -0.48 A, V _{GS} = 0 V	P-Ch		-0.8	-1.2	
Dynamic^b							
Total Gate Charge	Q _g	N-Channel V _{DS} = 10 V, V _{GS} = 4.5 V, I _D = 1.13 A P-Channel V _{DS} = -10 V, V _{GS} = -4.5 V, I _D = -0.88 A	N-Ch		0.65	1.0	nC
Gate-Source Charge	Q _{gs}		N-Ch		0.2		
			P-Ch		0.3		
Gate-Drain Charge	Q _{gd}	N-Ch		0.23			
		P-Ch		0.3			
Turn-On Delay Time	t _{d(on)}	N-Channel V _{DD} = 10 V, R _L = 20 Ω I _D ≅ 0.5 A, V _{GEN} = 4.5 V, R _G = 6 Ω P-Channel V _{DD} = -10 V, R _L = 20 Ω I _D ≅ -0.5 A, V _{GEN} = -4.5 V, R _G = 6 Ω	N-Ch		45	70	ns
Rise Time	t _r		N-Ch		85	130	
			P-Ch		480	720	
Turn-Off Delay Time	t _{d(off)}		N-Ch		350	530	
			P-Ch		840	1200	
Fall Time	t _f		N-Ch		210	320	
		P-Ch		850	1200		

Notes

- a. Pulse test; pulse width ≤ 300 μs, duty cycle ≤ 2%.
b. Guaranteed by design, not subject to production testing.



TYPICAL CHARACTERISTICS (25°C UNLESS NOTED)

N-CHANNEL

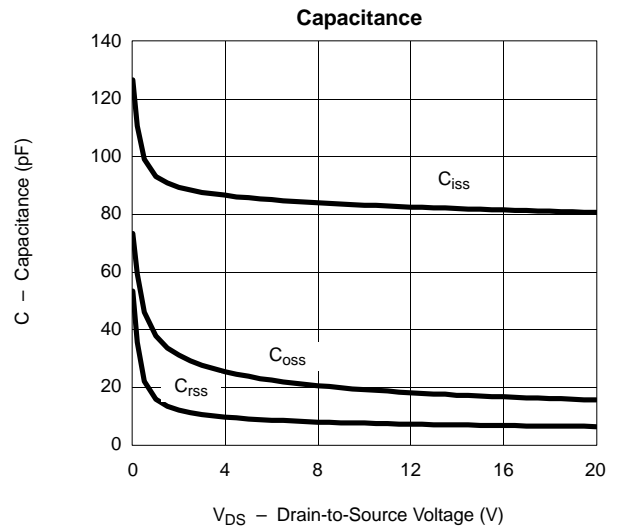
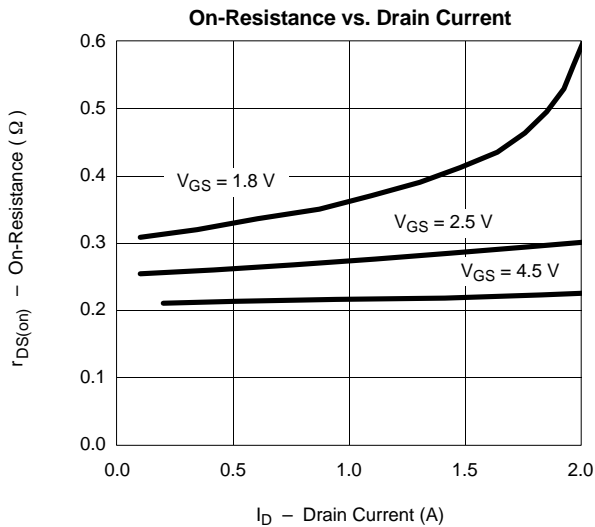
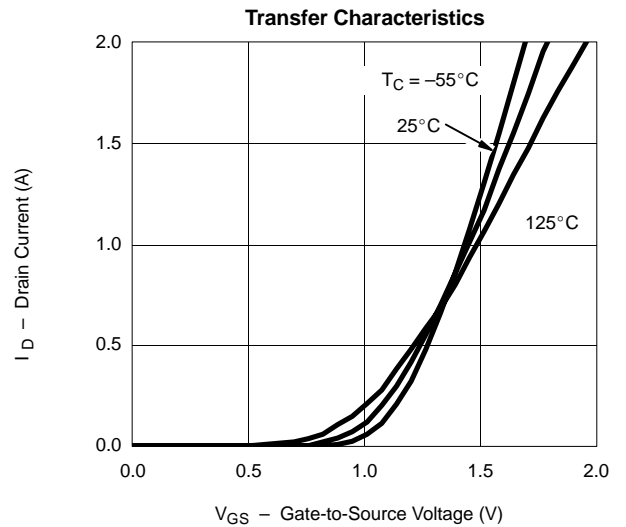
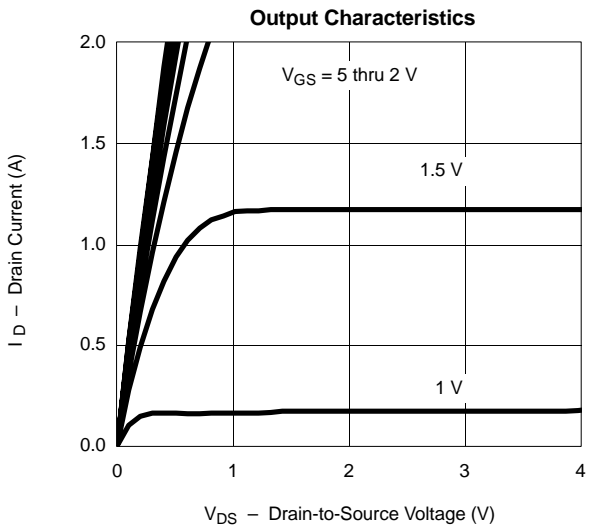
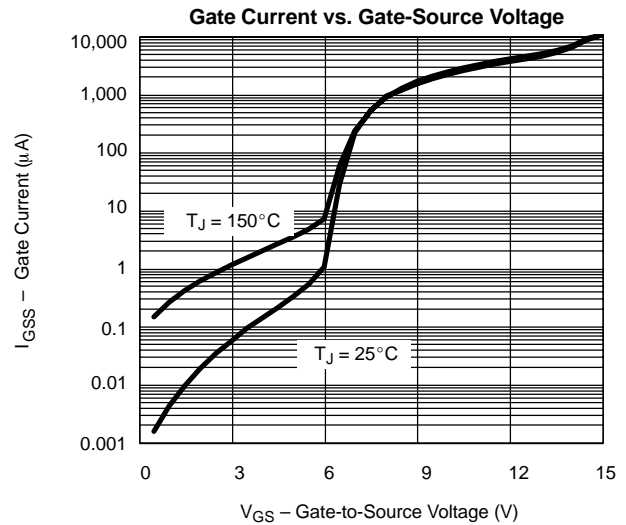
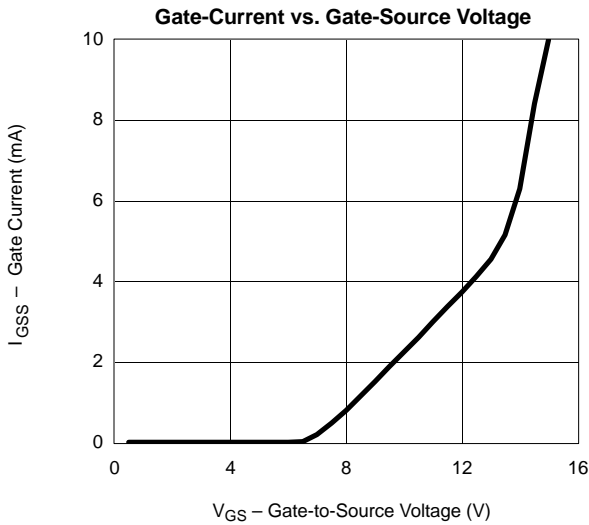

TYPICAL CHARACTERISTICS (25°C UNLESS NOTED)

N-CHANNEL

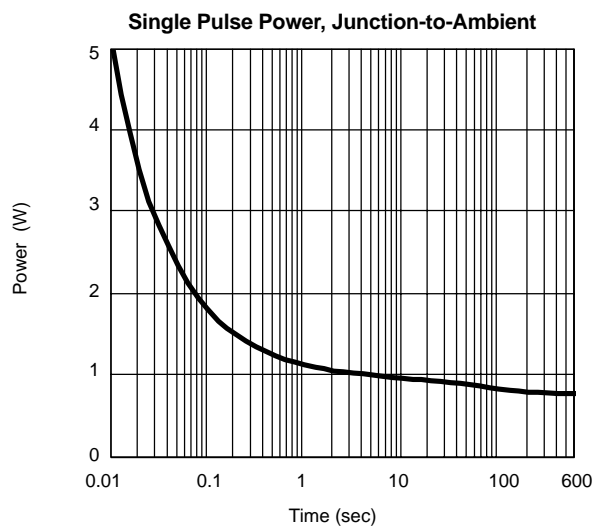
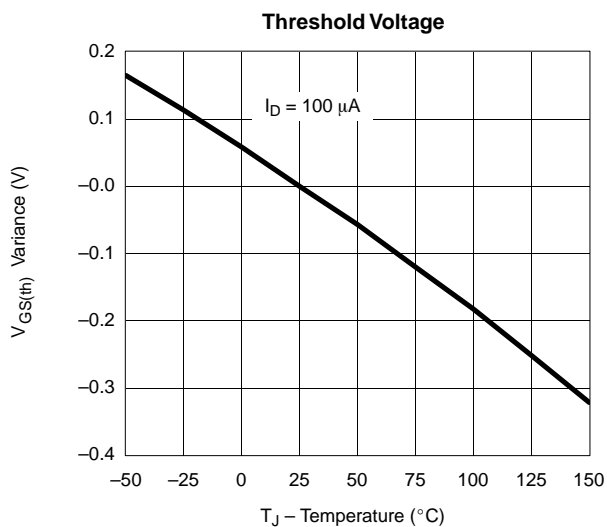
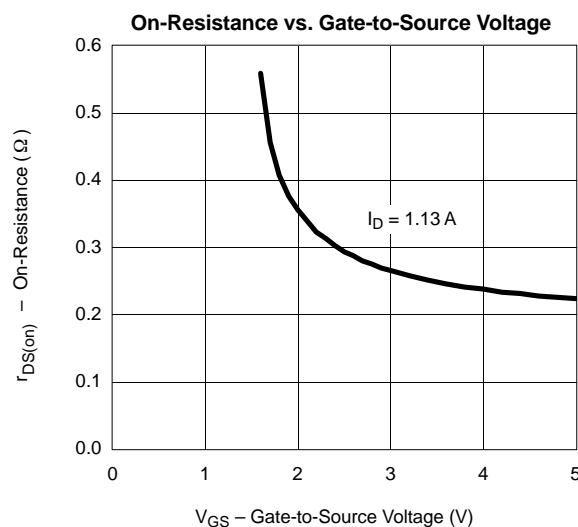
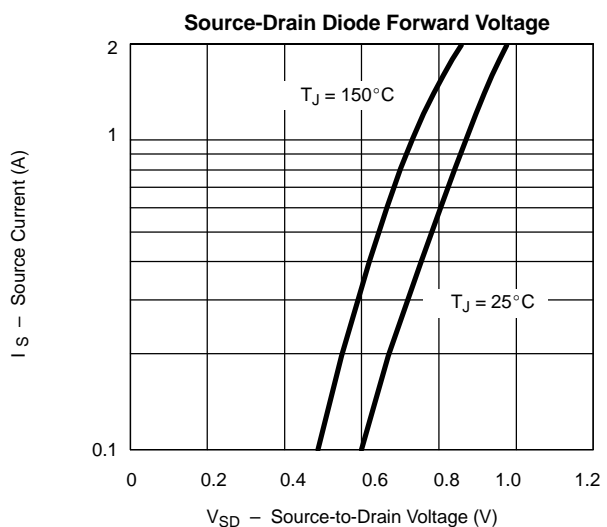
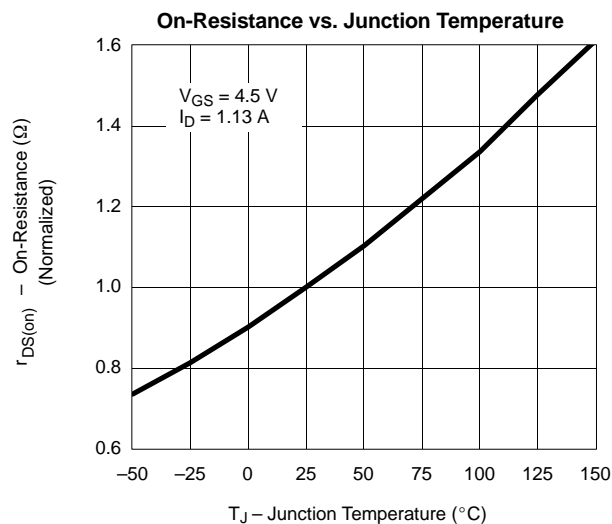
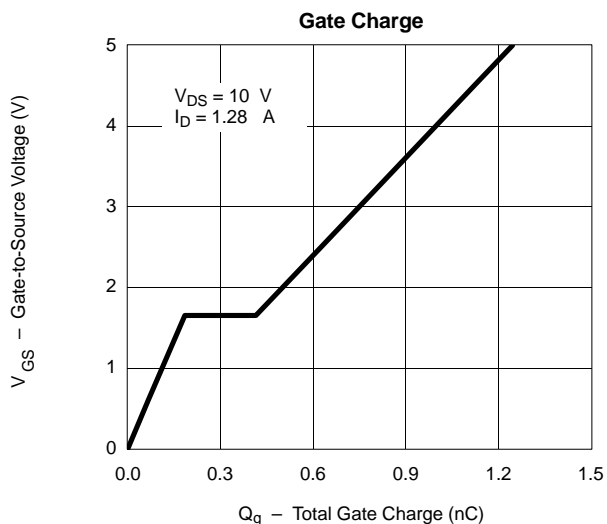



TYPICAL CHARACTERISTICS (25°C UNLESS NOTED)

N-CHANNEL

Normalized Thermal Transient Impedance, Junction-to-Ambient

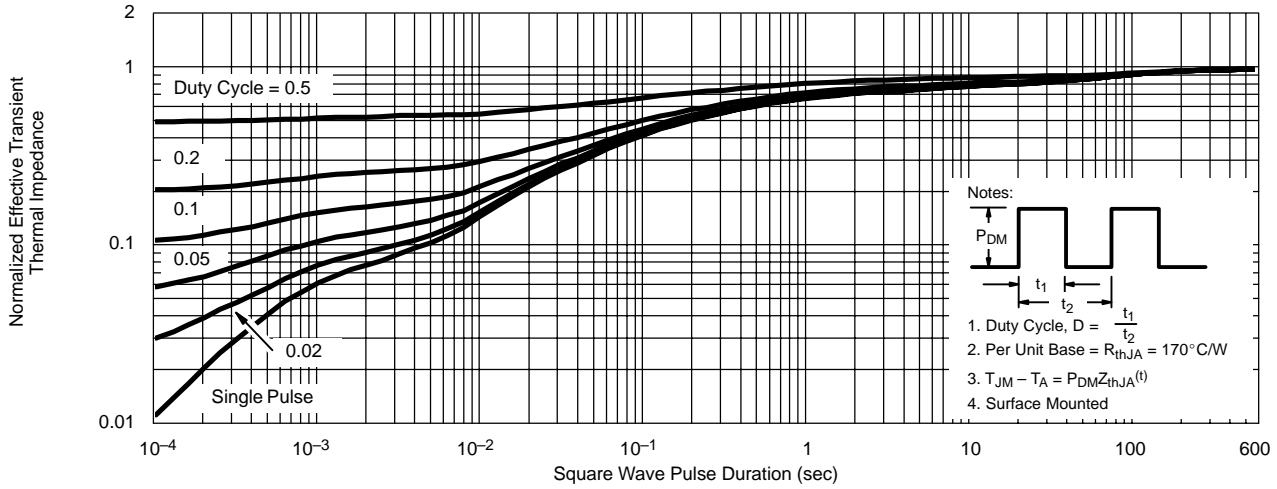

Normalized Thermal Transient Impedance, Junction-to-Foot

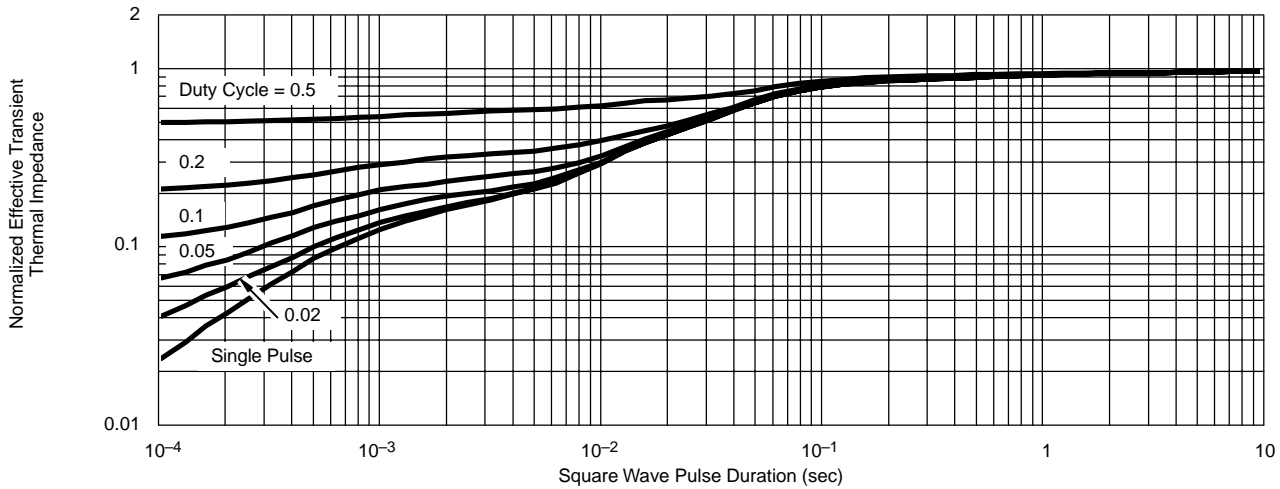

TYPICAL CHARACTERISTICS (25°C UNLESS NOTED)

P-CHANNEL

Gate-Current vs. Gate-Source Voltage

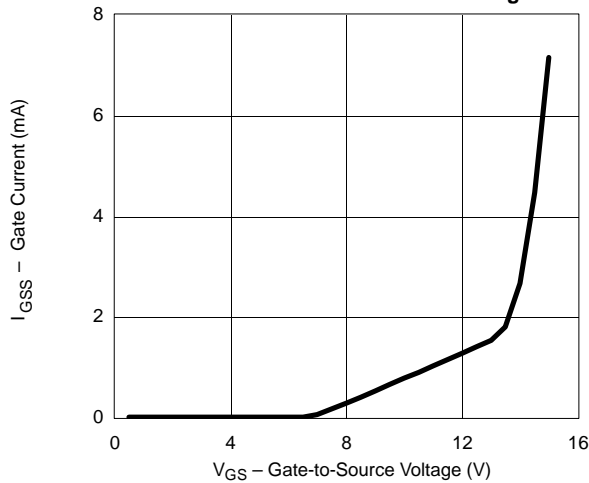

Gate Current vs. Gate-Source Voltage

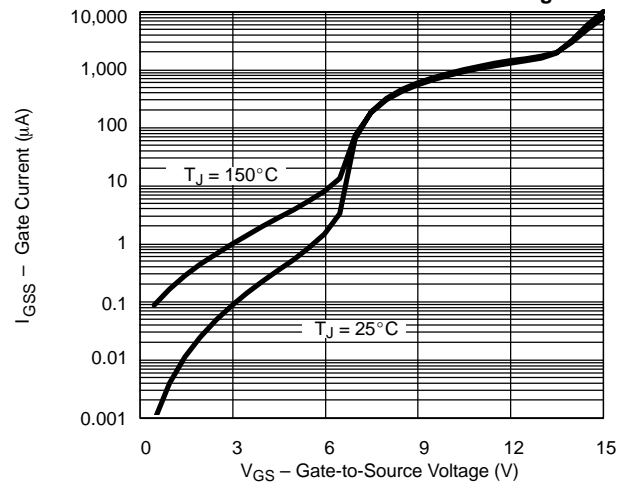

TYPICAL CHARACTERISTICS (25 °C UNLESS NOTED)

P-CHANNEL

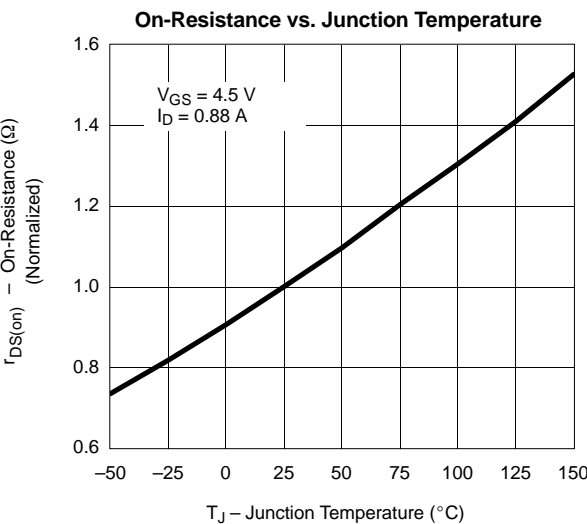
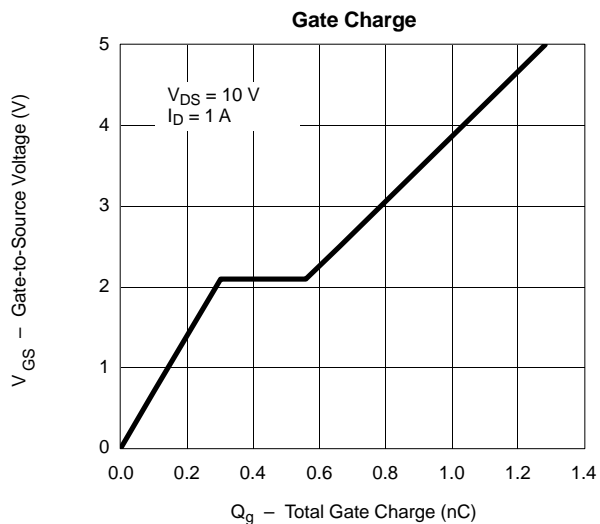
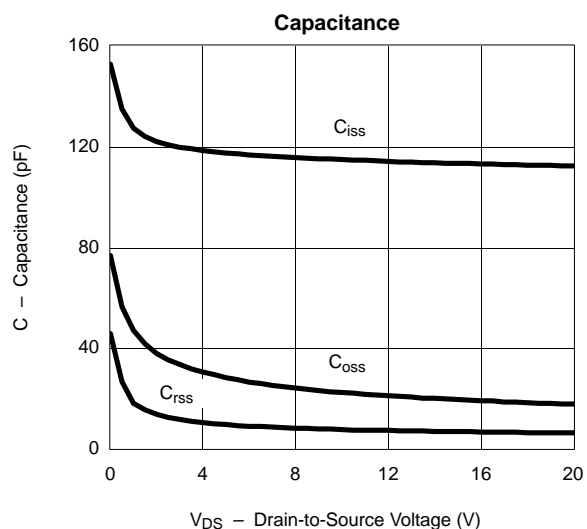
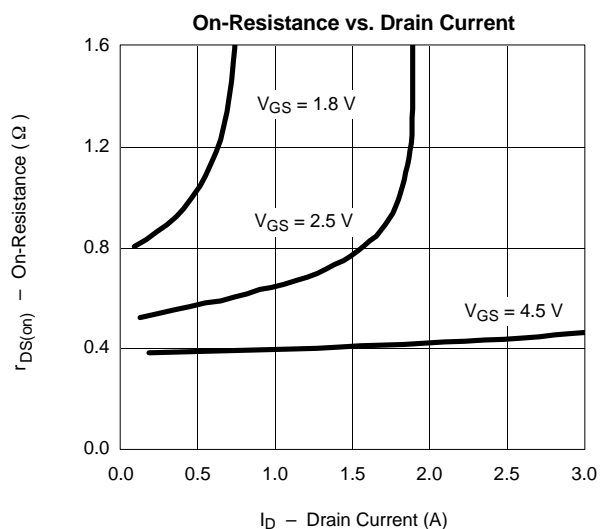
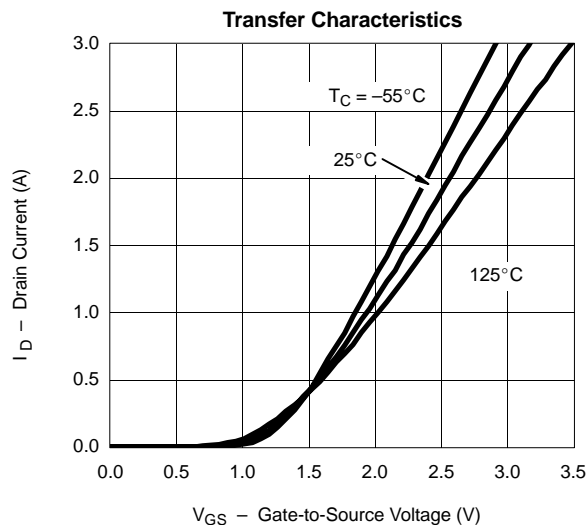
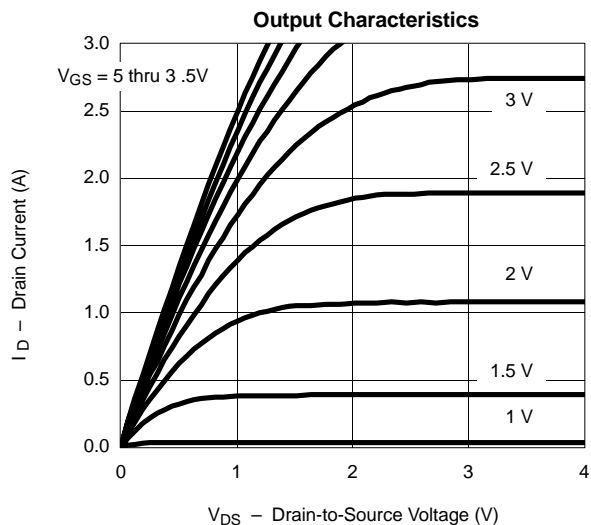



TYPICAL CHARACTERISTICS (25°C UNLESS NOTED)

P-CHANNEL

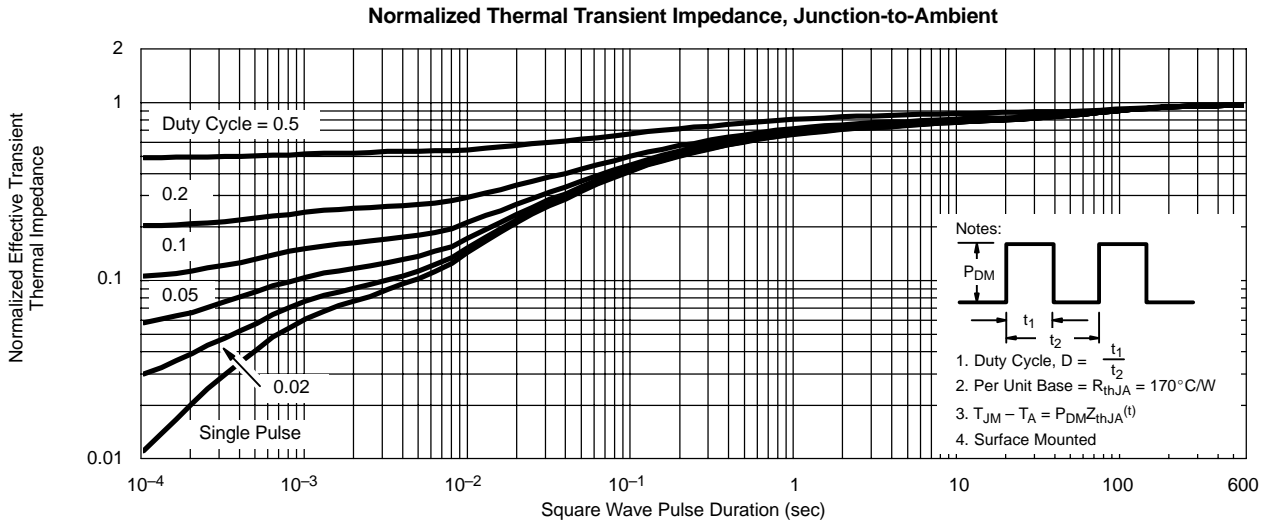
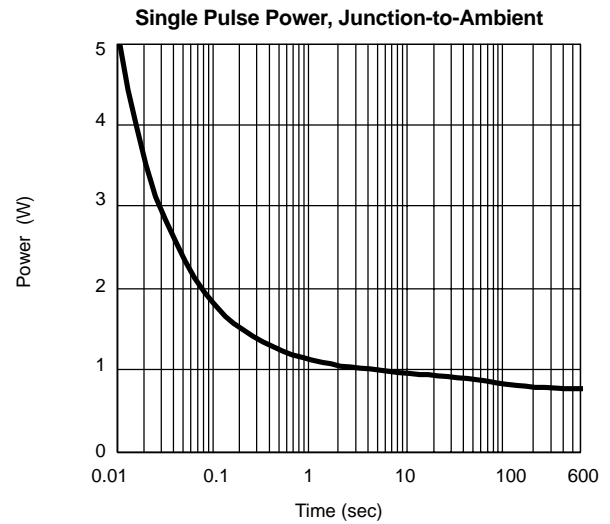
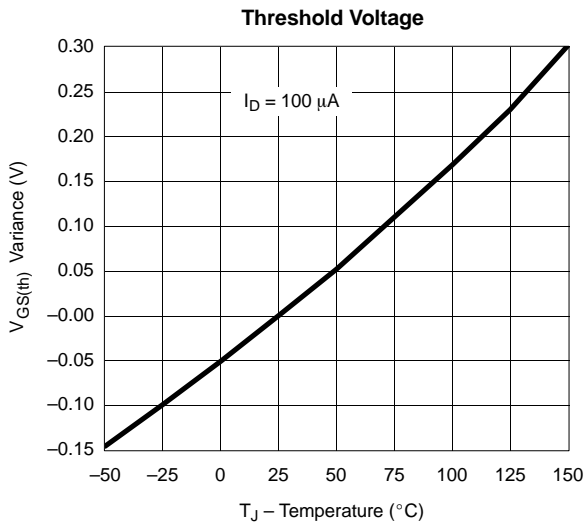
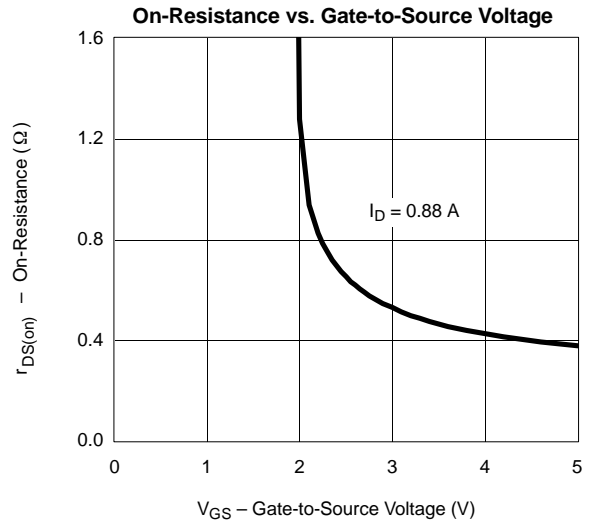
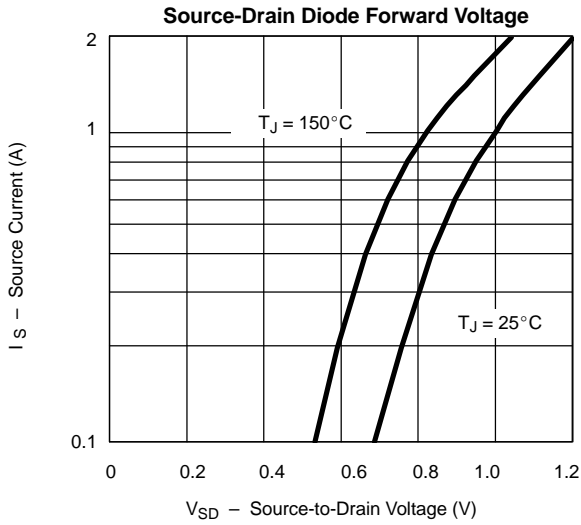

TYPICAL CHARACTERISTICS (25 °C UNLESS NOTED)

