



ON Semiconductor®

<http://onsemi.com>

PCP1403

N-Channel Power MOSFET 60V, 4.5A, 117mΩ, Single PCP

Features

- On-resistance $R_{DS(on)1}=92m\Omega$ (typ.)
- 4V drive
- Protection Diode in
- Halogen free compliance

Specifications

Absolute Maximum Ratings at $T_a = 25^\circ\text{C}$

Parameter	Symbol	Conditions	Value	Unit
Drain to Source Voltage	V_{DSS}		60	V
Gate to Source Voltage	V_{GSS}		± 20	V
Drain Current (DC)	I_D		4.5	A
Drain Current (Pulse)	I_{DP}	$PW \leq 10\mu s$, duty cycles $\leq 1\%$	18	A
Power Dissipation	P_D	$T_c = 25^\circ\text{C}$	3.5	W
		When mounted on ceramic substrate (600mm ² ×0.8mm)	1.3	W
Junction Temperature	T_j		150	$^\circ\text{C}$
Storage Temperature	T_{stg}		- 55 to +150	$^\circ\text{C}$

Stresses exceeding those listed in the Maximum Ratings table may damage the device. If any of these limits are exceeded, device functionality should not be assumed, damage may occur and reliability may be affected.

Thermal Resistance Ratings

Parameter	Symbol	Value	Unit
Junction to Case Steady State	$R_{\theta JC}$	35.7	$^\circ\text{C}/\text{W}$
Junction to Ambient When mounted on ceramic substrate (600mm ² ×0.8mm)	$R_{\theta JA}$	96.1	$^\circ\text{C}/\text{W}$

Electrical Characteristics at $T_a = 25^\circ\text{C}$

Parameter	Symbol	Conditions	Value			Unit
			min	typ	max	
Drain to Source Breakdown Voltage	$V_{(BR)DSS}$	$I_D=1mA$, $V_{GS}=0V$	60			V
Zero-Gate Voltage Drain Current	I_{DSS}	$V_{DS}=60V$, $V_{GS}=0V$			1	μA
Gate to Source Leakage Current	I_{GSS}	$V_{GS}=\pm 16V$, $V_{DS}=0V$			± 10	μA
Gate Threshold Voltage	$V_{GS(th)}$	$V_{DS}=10V$, $I_D=1mA$	1.2		2.6	V
Forward Transconductance	g_{FS}	$V_{DS}=10V$, $I_D=2A$		2.5		S
Static Drain to Source On-State Resistance	$R_{DS(on)1}$	$I_D=2A$, $V_{GS}=10V$		92	117	$m\Omega$
	$R_{DS(on)2}$	$I_D=1A$, $V_{GS}=4.5V$		120	168	$m\Omega$
	$R_{DS(on)3}$	$I_D=1A$, $V_{GS}=4V$		132	185	$m\Omega$
Input Capacitance	C_{iss}	$V_{DS}=20V$, $f=1\text{MHz}$		310		pF
Output Capacitance	C_{oss}			40		pF
Reverse Transfer Capacitance	C_{rss}			25		pF

Continued on next page.

ORDERING INFORMATION

See detailed ordering and shipping information on page 2 of this data sheet.

PCP1403

Continued from preceding page.

Parameter	Symbol	Conditions	Value			Unit
			min	typ	max	
Turn-ON Delay Time	$t_{d(on)}$	See specified Test Circuit		5.6		ns
Rise Time	t_r			7.0		ns
Turn-OFF Delay Time	$t_{d(off)}$			26		ns
Fall Time	t_f			14		ns
Total Gate Charge	Q_g	$V_{DS}=30V, V_{GS}=10V, I_D=4.5A$		6.7		nC
Gate to Source Charge	Q_{gs}			1.0		nC
Gate to Drain "Miller" Charge	Q_{gd}			1.6		nC
Forward Diode Voltage	V_{SD}	$I_S=4.5A, V_{GS}=0V$		0.88	1.2	V

Product parametric performance is indicated in the Electrical Characteristics for the listed test conditions, unless otherwise noted. Product performance may not be indicated by the Electrical Characteristics if operated under different conditions.

Ordering & Package Information

Device	Package	Shipping	note
PCP1403-TD-H	PCP, SC-62 SOT-89, TO-243	1,000 pcs. / reel	Pb-Free and Halogen Free

Packing Type:TD

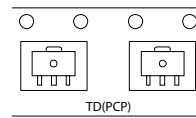

Marking

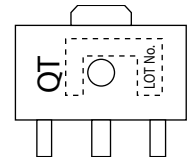

Electrical Connection

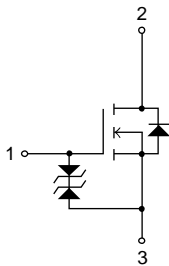

Switching Time Test Circuit

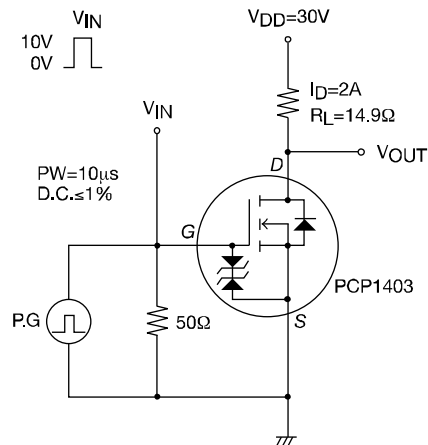

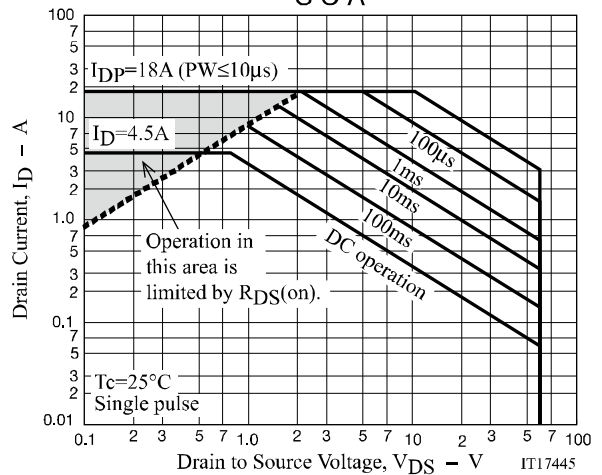
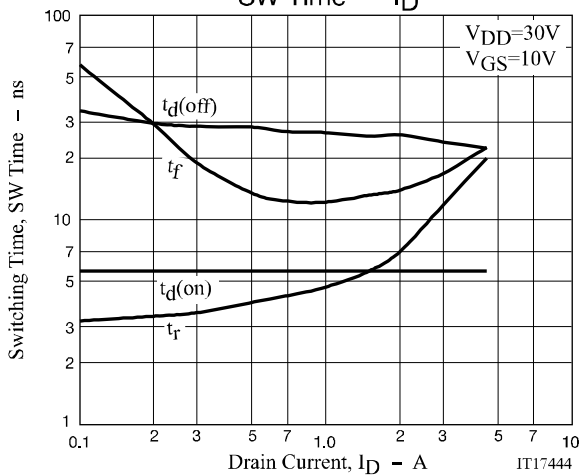
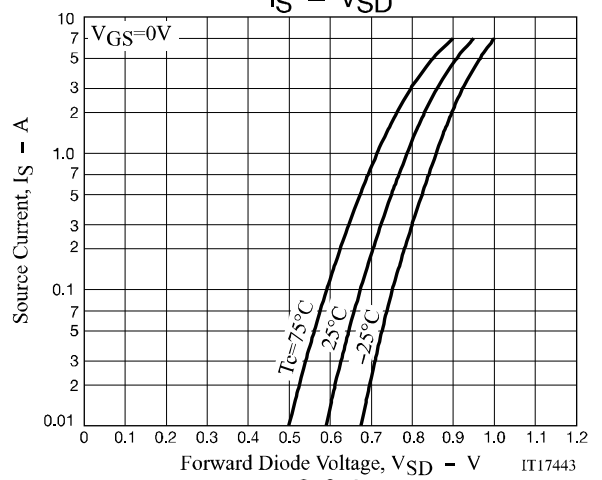
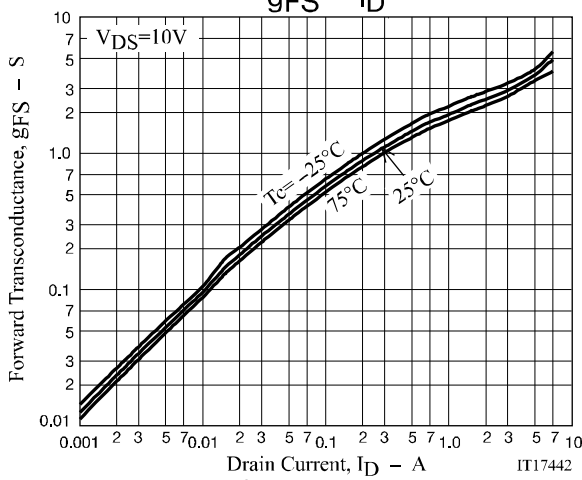
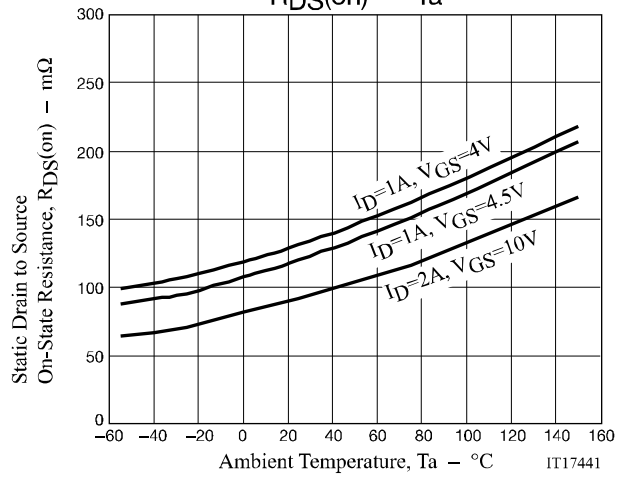
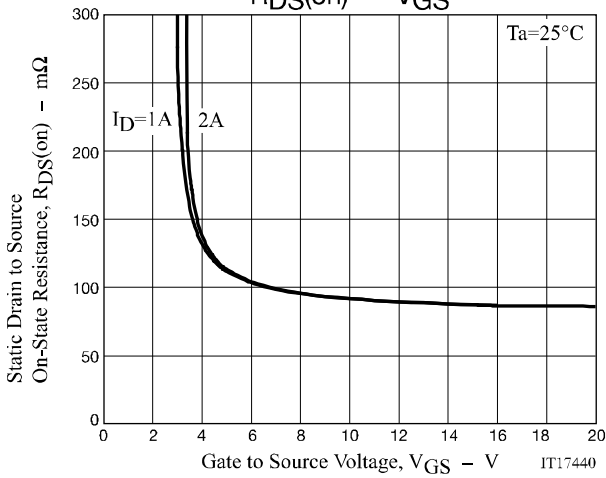
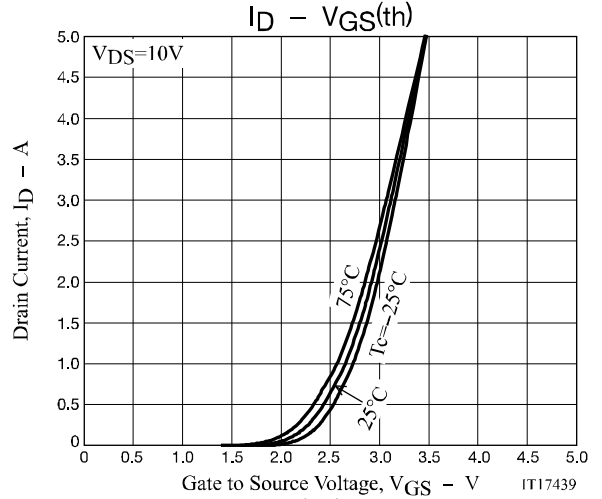
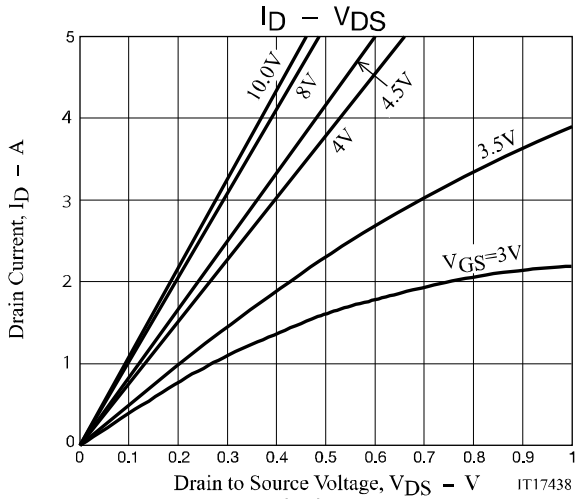

PCP1403

