

The RF Sub-Micron MOSFET Line  
**RF Power Field Effect Transistor**  
N-Channel Enhancement-Mode Lateral MOSFET

**MRF6522-5R1**

**960 MHz, 5.0 W, 26 V  
LATERAL N-CHANNEL  
RF POWER MOSFET**

Designed for Class A and Class AB common source, linear power amplifiers in the 960 MHz range. The MRF6522-5R1 has been specifically designed for use in Communications Network (GSM) base stations. The package offers the advantage of SMD.

- Specified 26 Volts, 960 MHz, Class AB Characteristics  
Output Power = 5.0 Watts CW  
Power Gain = 17 dB Min @ 960 MHz, 5.0 Watts CW  
Efficiency = 50% Min @ 960 MHz, 5.0 Watts CW
- Excellent Thermal Stability
- Characterized with Series Equivalent Large-Signal Impedance Parameters
- S-Parameter Characterization at High Bias Levels
- Bottom Side Source Eliminates DC Isolators, Reducing Common Mode Inductances
- Available in Tape and Reel. R1 Suffix = 500 Units per 12 mm, 7 inch Reel.

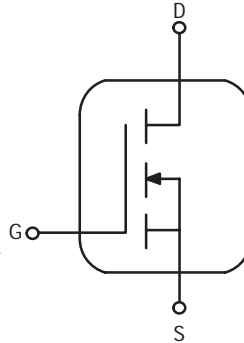

CASE 458C-02, STYLE 1

**MAXIMUM RATINGS**

Rating	Symbol	Value	Unit
Drain-Source Voltage	$V_{DSS}$	65	Vdc
Gate-Source Voltage	$V_{GS}$	$\pm 20$	Vdc
Total Device Dissipation @ $T_C = 25^\circ\text{C}$ Derate above $25^\circ\text{C}$	$P_D$	11.7 0.067	Watts W/ $^\circ\text{C}$
Storage Temperature Range	$T_{stg}$	-65 to +150	$^\circ\text{C}$
Operating Junction Temperature	$T_J$	200	$^\circ\text{C}$

**THERMAL CHARACTERISTICS**

Characteristic	Symbol	Max	Unit
Thermal Resistance, Junction to Case (1)	$R_{\theta JC}$	6.86	$^\circ\text{C}/\text{W}$

**ELECTRICAL CHARACTERISTICS** ( $T_C = 25^\circ\text{C}$  unless otherwise noted)

Characteristic	Symbol	Min	Typ	Max	Unit
----------------	--------	-----	-----	-----	------

**OFF CHARACTERISTICS**

Drain-Source Breakdown Voltage ( $V_{GS} = 0$ Vdc, $I_D = 0.2$ mA)	$V_{(BR)DSS}$	65	—	—	Vdc
Zero Gate Voltage Drain Current ( $V_{DS} = 26$ Vdc, $V_{GS} = 0$ )	$I_{DSS}$	—	—	1.0	$\mu\text{Adc}$
Gate-Source Leakage Current ( $V_{GS} = 20$ Vdc, $V_{DS} = 0$ )	$I_{GSS}$	—	—	1.0	$\mu\text{Adc}$

(1) Thermal resistance is determined under specified RF operating condition.

NOTE - **CAUTION** - MOS devices are susceptible to damage from electrostatic charge. Reasonable precautions in handling and packaging MOS devices should be observed.

LIFETIME BUY

LAST SHIP 31JAN05  
LAST ORDER 31JUL04

**ELECTRICAL CHARACTERISTICS continued** ( $T_C = 25^\circ\text{C}$  unless otherwise noted)

Characteristic	Symbol	Min	Typ	Max	Unit
----------------	--------	-----	-----	-----	------

**ON CHARACTERISTICS**

Gate Threshold Voltage ( $V_{DS} = 10\text{ V}$ , $I_D = 20\ \mu\text{A}$ )	$V_{GS(th)}$	1.25	3.0	4.0	Vdc
Gate Quiescent Voltage ( $V_{DS} = 26\text{ Vdc}$ , $I_D = 50\text{ mA}$ )	$V_{GS(Q)}$	2.25	4.0	5.0	Vdc
Drain–Source On–Voltage ( $V_{GS} = 10\text{ V}$ , $I_D = 0.25\text{ A}$ )	$V_{DS(on)}$	—	—	0.7	Vdc

**DYNAMIC CHARACTERISTICS**

Input Capacitance ( $V_{DS} = 26\text{ V}$ , $V_{GS} = 0\text{ V}$ , $f = 1.0\text{ MHz}$ )	$C_{iss}$	—	6.0	—	pF
Output Capacitance ( $V_{DS} = 26\text{ V}$ , $V_{GS} = 0\text{ V}$ , $f = 1.0\text{ MHz}$ )	$C_{oss}$	—	3.7	—	pF
Reverse Transfer Capacitance ( $V_{DS} = 26\text{ V}$ , $V_{GS} = 0\text{ V}$ , $f = 1.0\text{ MHz}$ )	$C_{rss}$	—	0.3	—	pF

**FUNCTIONAL TESTS** (In Motorola Test Fixture)

Common–Source Power Gain ( $V_{DS} = 26\text{ V}$ , $P_{out} = 5.0\text{ W CW}$ , $I_{DQ} = 50\text{ mA}$ , $f = 960\text{ MHz}$ )	$G_{ps}$	17	19	—	dB
Drain Efficiency ( $V_{DS} = 26\text{ V}$ , $P_{out} = 5.0\text{ W CW}$ , $I_{DQ} = 50\text{ mA}$ , $f = 960\text{ MHz}$ )	$\eta$	50	55	—	%
Input Return Loss ( $V_{DS} = 26\text{ V}$ , $P_{out} = 5.0\text{ W CW}$ , $I_{DQ} = 50\text{ mA}$ , $f = 960\text{ MHz}$ )	IRL	—	—	–9	dB

LIFETIME BUY

LAST SHIP 31 JAN 05  
LAST ORDER 31 JUL 04

## TYPICAL CHARACTERISTICS

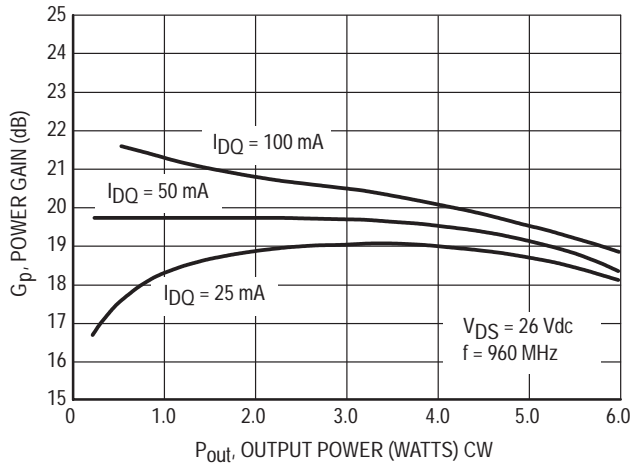

Figure 1. Power Gain versus Output Power

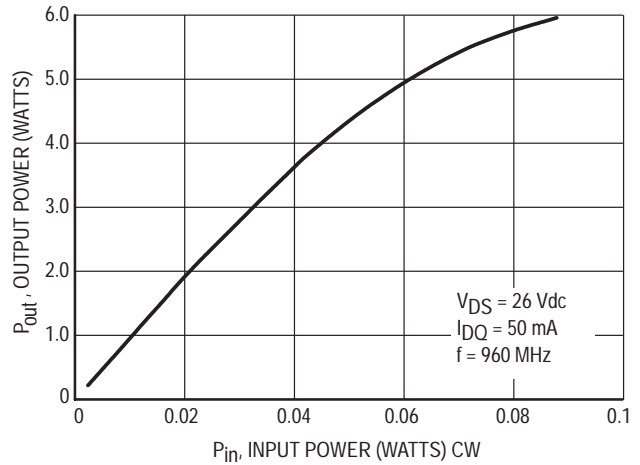

Figure 2. Output Power versus Input Power

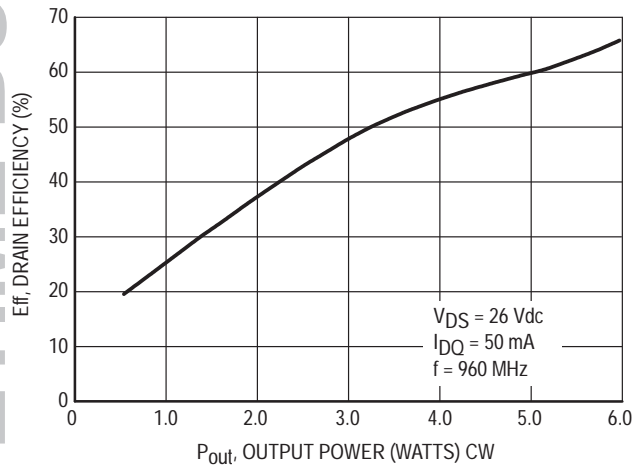

Figure 3. Drain Efficiency versus Output Power

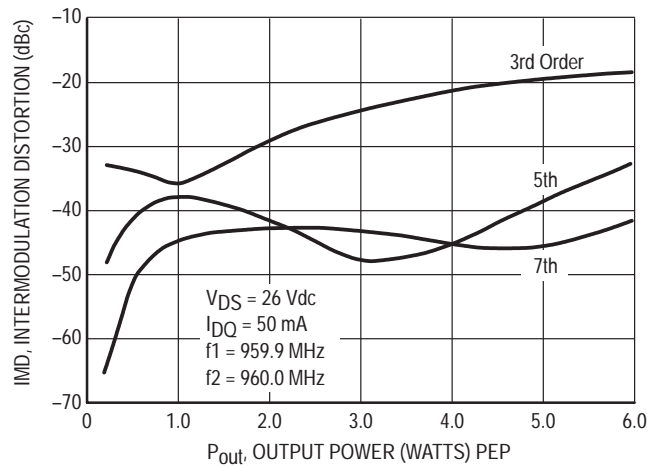
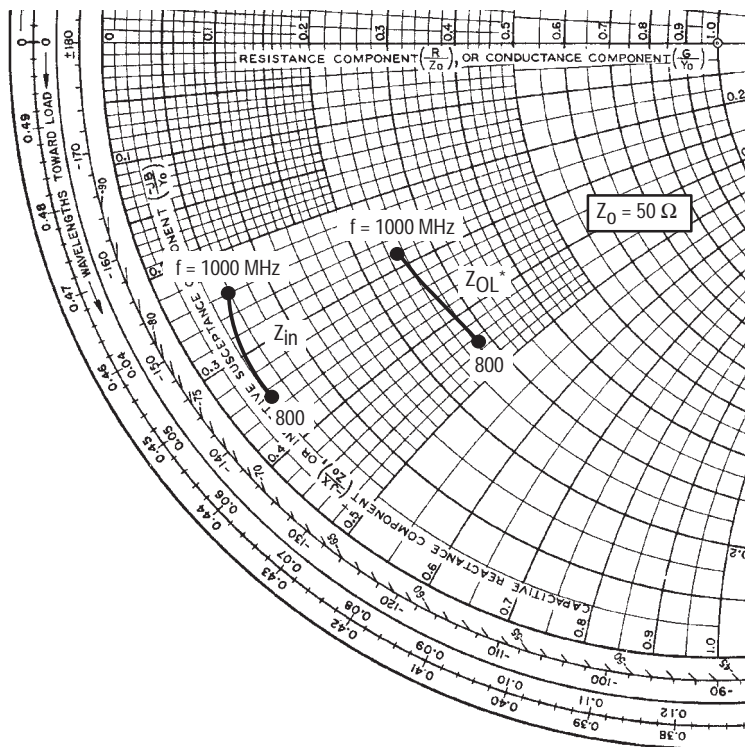

Figure 4. Intermodulation Distortion Products versus Output Power

LIFETIME BUY

LAST ORDER 31JUL04 LAST SHIP 31JAN05



f MHz	Z <sub>in</sub> Ohms	Z <sub>OL</sub> * Ohms
800	2.40 - j17.4	14.7 - j22.8
825	2.46 - j16.4	14.1 - j20.8
850	2.50 - j15.8	14.0 - j19.5
875	2.56 - j15.2	13.9 - j17.9
900	2.60 - j14.7	13.8 - j17.3
925	2.71 - j13.7	13.7 - j16.9
950	2.78 - j13.2	13.2 - j15.6
975	2.88 - j12.6	12.9 - j14.4
1000	3.06 - j11.9	12.9 - j14.2

Z<sub>in</sub> = Complex conjugate of source impedance.

Z<sub>OL</sub>\* = Complex conjugate of the optimum load impedance into which the device operates at a given output power, voltage, current and frequency.

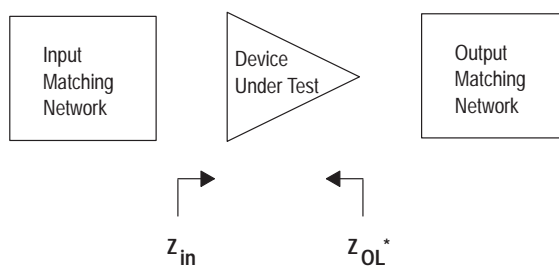

Figure 5. Series Equivalent Input and Output Impedance

Table 1. Common Source S-Parameters at  $V_{DS} = 12$  Vdc,  $I_D = 50$  mAdc

f GHz	S <sub>11</sub>		S <sub>21</sub>		S <sub>12</sub>		S <sub>22</sub>	
	S <sub>11</sub>	φ	S <sub>21</sub>	φ	S <sub>12</sub>	φ	S <sub>22</sub>	φ
0.500	0.786	-114	5.16	87	0.074	2	0.711	-100
0.525	0.782	-117	4.94	84	0.073	-1	0.709	-102
0.550	0.779	-120	4.74	82	0.074	-2	0.707	-105
0.575	0.777	-122	4.55	79	0.073	-5	0.706	-107
0.600	0.776	-124	4.37	77	0.073	-7	0.707	-109
0.625	0.775	-127	4.20	75	0.073	-9	0.707	-111
0.650	0.774	-129	4.03	73	0.072	-12	0.707	-113
0.675	0.774	-131	3.89	70	0.072	-13	0.710	-115
0.700	0.773	-133	3.74	68	0.071	-14	0.711	-117
0.725	0.774	-134	3.61	66	0.071	-16	0.712	-119
0.750	0.775	-136	3.48	64	0.070	-18	0.715	-120
0.775	0.775	-138	3.36	63	0.069	-20	0.717	-122
0.800	0.776	-139	3.25	61	0.069	-21	0.720	-124
0.825	0.777	-141	3.14	59	0.068	-23	0.723	-125
0.850	0.778	-143	3.03	57	0.067	-25	0.728	-128
0.875	0.779	-144	2.93	55	0.067	-26	0.730	-129
0.900	0.780	-146	2.84	53	0.066	-28	0.733	-130
0.925	0.781	-147	2.75	51	0.064	-29	0.737	-132
0.950	0.783	-149	2.66	50	0.065	-30	0.740	-133
0.975	0.785	-150	2.58	48	0.063	-32	0.742	-134
1.000	0.786	-151	2.51	47	0.063	-33	0.745	-136

Table 2. Common Source S-Parameters at  $V_{DS} = 12$  Vdc,  $I_D = 100$  mAdc

f GHz	S <sub>11</sub>		S <sub>21</sub>		S <sub>12</sub>		S <sub>22</sub>	
	S <sub>11</sub>	φ	S <sub>21</sub>	φ	S <sub>12</sub>	φ	S <sub>22</sub>	φ
0.500	0.757	-122	6.36	86	0.066	2	0.652	-107
0.525	0.754	-124	6.09	84	0.065	-1	0.650	-109
0.550	0.752	-127	5.84	81	0.065	-3	0.649	-111
0.575	0.750	-129	5.60	79	0.065	-5	0.648	-113
0.600	0.749	-131	5.37	77	0.065	-7	0.649	-115
0.625	0.748	-133	5.16	75	0.065	-8	0.650	-117
0.650	0.747	-135	4.96	73	0.065	-10	0.651	-119
0.675	0.747	-137	4.78	71	0.064	-12	0.654	-121
0.700	0.746	-139	4.60	69	0.064	-14	0.655	-123
0.725	0.747	-140	4.43	67	0.062	-15	0.658	-124
0.750	0.747	-142	4.28	65	0.062	-17	0.660	-126
0.775	0.748	-144	4.13	63	0.062	-18	0.663	-127
0.800	0.748	-145	3.99	61	0.062	-20	0.667	-129
0.825	0.749	-147	3.86	60	0.061	-21	0.670	-130
0.850	0.751	-148	3.73	58	0.060	-22	0.674	-132
0.875	0.751	-150	3.61	56	0.060	-25	0.679	-134
0.900	0.752	-151	3.50	54	0.059	-25	0.681	-135
0.925	0.755	-152	3.39	53	0.058	-27	0.686	-136
0.950	0.756	-154	3.29	51	0.058	-28	0.689	-137
0.975	0.757	-155	3.19	50	0.056	-29	0.692	-139
1.000	0.760	-156	3.10	48	0.056	-30	0.695	-140

LIFETIME BUY

LAST SHIP 31JAN05  
LAST ORDER 31JUL04

Table 3. Common Source S-Parameters at  $V_{DS} = 12 \text{ Vdc}$ ,  $I_D = 200 \text{ mAdc}$

f GHz	S <sub>11</sub>		S <sub>21</sub>		S <sub>12</sub>		S <sub>22</sub>	
	S <sub>11</sub>	φ	S <sub>21</sub>	φ	S <sub>12</sub>	φ	S <sub>22</sub>	φ
0.500	0.743	-128	7.18	85	0.059	1	0.607	-113
0.525	0.740	-130	6.87	83	0.059	-1	0.607	-115
0.550	0.739	-132	6.58	81	0.060	-3	0.608	-117
0.575	0.736	-134	6.30	79	0.059	-4	0.608	-119
0.600	0.735	-137	6.05	76	0.059	-7	0.610	-121
0.625	0.735	-138	5.81	74	0.059	-8	0.610	-123
0.650	0.734	-140	5.58	72	0.059	-10	0.612	-124
0.675	0.734	-142	5.38	71	0.058	-11	0.615	-126
0.700	0.733	-144	5.18	69	0.057	-12	0.616	-128
0.725	0.733	-145	4.99	67	0.057	-14	0.620	-129
0.750	0.734	-147	4.82	65	0.057	-16	0.622	-130
0.775	0.735	-148	4.66	64	0.056	-17	0.626	-132
0.800	0.735	-150	4.50	62	0.056	-18	0.630	-133
0.825	0.736	-151	4.35	60	0.055	-19	0.633	-135
0.850	0.737	-153	4.21	58	0.054	-21	0.638	-136
0.875	0.739	-154	4.07	57	0.054	-22	0.642	-138
0.900	0.739	-155	3.95	55	0.053	-24	0.645	-139
0.925	0.741	-156	3.83	53	0.053	-25	0.649	-140
0.950	0.742	-158	3.71	52	0.053	-26	0.653	-141
0.975	0.744	-159	3.61	51	0.052	-27	0.656	-142
1.000	0.746	-160	3.51	49	0.051	-28	0.661	-143

Table 4. Common Source S-Parameters at  $V_{DS} = 26 \text{ Vdc}$ ,  $I_D = 50 \text{ mAdc}$

f GHz	S <sub>11</sub>		S <sub>21</sub>		S <sub>12</sub>		S <sub>22</sub>	
	S <sub>11</sub>	φ	S <sub>21</sub>	φ	S <sub>12</sub>	φ	S <sub>22</sub>	φ
0.500	0.847	-109	6.45	93	0.047	10	0.729	-80
0.525	0.844	-112	6.20	90	0.047	7	0.726	-83
0.550	0.841	-114	5.98	88	0.046	5	0.724	-85
0.575	0.838	-117	5.75	85	0.047	2	0.722	-88
0.600	0.836	-119	5.54	83	0.047	1	0.721	-90
0.625	0.834	-122	5.36	80	0.047	-2	0.720	-92
0.650	0.831	-124	5.16	78	0.047	-4	0.721	-94
0.675	0.831	-126	4.98	76	0.046	-6	0.722	-96
0.700	0.829	-128	4.81	73	0.045	-8	0.721	-98
0.725	0.827	-130	4.64	71	0.045	-10	0.724	-100
0.750	0.828	-132	4.49	69	0.045	-11	0.725	-102
0.775	0.827	-134	4.35	67	0.045	-12	0.727	-104
0.800	0.826	-136	4.21	65	0.044	-15	0.730	-106
0.825	0.826	-138	4.08	63	0.043	-16	0.731	-107
0.850	0.826	-140	3.94	61	0.043	-18	0.734	-110
0.875	0.826	-141	3.82	59	0.042	-19	0.738	-111
0.900	0.826	-143	3.71	57	0.042	-19	0.740	-113
0.925	0.827	-145	3.59	55	0.041	-22	0.743	-115
0.950	0.827	-146	3.49	54	0.041	-24	0.745	-116
0.975	0.828	-148	3.39	52	0.040	-25	0.747	-117
1.000	0.828	-149	3.30	50	0.039	-26	0.751	-119

LIFETIME BUY

LAST SHIP 31JAN05  
LAST ORDER 31JUL04

Table 5. Common Source S-Parameters at  $V_{DS} = 26$  Vdc,  $I_D = 150$  mAdc

f GHz	S <sub>11</sub>		S <sub>21</sub>		S <sub>12</sub>		S <sub>22</sub>	
	S <sub>11</sub>	φ	S <sub>21</sub>	φ	S <sub>12</sub>	φ	S <sub>22</sub>	φ
0.500	0.826	-117	8.37	91	0.039	8	0.626	-85
0.525	0.822	-120	8.04	89	0.039	7	0.625	-88
0.550	0.818	-122	7.74	86	0.039	6	0.623	-90
0.575	0.815	-125	7.43	84	0.039	3	0.622	-92
0.600	0.813	-127	7.16	81	0.038	1	0.624	-94
0.625	0.811	-130	6.90	79	0.038	-1	0.624	-96
0.650	0.808	-132	6.65	77	0.038	-3	0.626	-98
0.675	0.808	-134	6.41	75	0.038	-5	0.627	-100
0.700	0.807	-136	6.19	73	0.038	-5	0.629	-102
0.725	0.806	-138	5.97	71	0.037	-8	0.631	-104
0.750	0.805	-139	5.78	69	0.037	-10	0.635	-106
0.775	0.805	-141	5.59	67	0.037	-11	0.637	-107
0.800	0.804	-143	5.41	65	0.036	-11	0.640	-109
0.825	0.805	-145	5.24	63	0.036	-13	0.643	-111
0.850	0.804	-146	5.07	61	0.034	-14	0.648	-113
0.875	0.805	-148	4.92	59	0.035	-16	0.652	-114
0.900	0.803	-149	4.77	58	0.034	-17	0.655	-116
0.925	0.805	-151	4.63	56	0.034	-18	0.659	-117
0.950	0.806	-152	4.50	54	0.033	-19	0.663	-119
0.975	0.806	-154	4.37	53	0.032	-21	0.666	-120
1.000	0.807	-155	4.25	51	0.031	-22	0.671	-121

Table 6. Common Source S-Parameters at  $V_{DS} = 26$  Vdc,  $I_D = 300$  mAdc

f GHz	S <sub>11</sub>		S <sub>21</sub>		S <sub>12</sub>		S <sub>22</sub>	
	S <sub>11</sub>	φ	S <sub>21</sub>	φ	S <sub>12</sub>	φ	S <sub>22</sub>	φ
0.500	0.827	-119	8.39	90	0.036	8	0.612	-84
0.525	0.824	-122	8.06	88	0.036	7	0.612	-86
0.550	0.821	-124	7.74	85	0.036	4	0.611	-89
0.575	0.818	-127	7.44	83	0.036	3	0.611	-91
0.600	0.816	-129	7.17	80	0.035	1	0.612	-93
0.625	0.814	-132	6.90	78	0.035	-1	0.613	-95
0.650	0.812	-134	6.65	76	0.036	-3	0.615	-97
0.675	0.811	-136	6.41	74	0.035	-5	0.617	-99
0.700	0.809	-138	6.19	72	0.035	-6	0.619	-101
0.725	0.809	-139	5.97	70	0.034	-8	0.622	-102
0.750	0.809	-141	5.77	68	0.034	-8	0.625	-104
0.775	0.808	-143	5.58	66	0.034	-10	0.628	-106
0.800	0.808	-145	5.40	64	0.033	-11	0.632	-108
0.825	0.808	-146	5.23	62	0.033	-13	0.635	-109
0.850	0.808	-148	5.06	60	0.032	-15	0.640	-111
0.875	0.808	-150	4.90	58	0.032	-16	0.644	-113
0.900	0.808	-151	4.76	56	0.032	-17	0.647	-114
0.925	0.808	-152	4.62	55	0.031	-18	0.652	-116
0.950	0.809	-154	4.48	53	0.030	-19	0.657	-117
0.975	0.809	-155	4.36	51	0.029	-20	0.659	-119
1.000	0.810	-157	4.23	50	0.029	-22	0.664	-120

LIFETIME BUY

LAST SHIP 31JAN05  
LAST ORDER 31JUL04

## PACKAGE DIMENSIONS

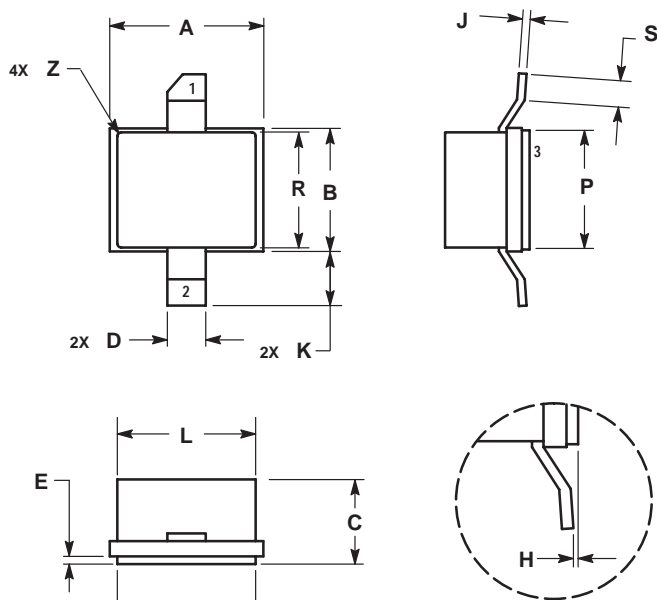

- NOTES:
1. CONTROLLING DIMENSIONS: INCHES.
  2. INTERPRET DIMENSIONS AND TOLERANCES PER ASME Y14.5M, 1994.
  3. DIMENSION H (PACKAGE COPLANARITY): THE BOTTOM OF LEADS AND REFERENCE PLANE T MUST BE COPLANAR WITHIN DIMENSION H.

DIM	INCHES		MILLIMETERS	
	MIN	MAX	MIN	MAX
A	0.197	0.203	5.004	5.156
B	0.157	0.163	3.988	4.140
C	0.085	0.110	2.159	2.794
D	0.047	0.053	1.194	1.346
E	0.004	0.010	0.102	0.254
H	0.000	0.004	0.000	0.102
J	0.004	0.010	0.102	0.254
K	0.050	0.090	1.270	2.286
L	0.177	0.183	4.496	4.648
N	0.180	0.200	4.572	5.080
P	0.140	0.160	3.556	4.064
R	0.147	0.153	3.734	3.886
Z	---	0.020	---	0.508

- STYLE 1:  
 PIN 1. DRAIN  
 2. GATE  
 3. SOURCE

**CASE 458C-02  
 ISSUE C**

LIFETIME BUY

LAST SHIP 31JAN05  
 LAST ORDER 31JUL04

Motorola reserves the right to make changes without further notice to any products herein. Motorola makes no warranty, representation or guarantee regarding the suitability of its products for any particular purpose, nor does Motorola assume any liability arising out of the application or use of any product or circuit, and specifically disclaims any and all liability, including without limitation consequential or incidental damages. "Typical" parameters which may be provided in Motorola data sheets and/or specifications can and do vary in different applications and actual performance may vary over time. All operating parameters, including "Typicals" must be validated for each customer application by customer's technical experts. Motorola does not convey any license under its patent rights nor the rights of others. Motorola products are not designed, intended, or authorized for use as components in systems intended for surgical implant into the body, or other applications intended to support or sustain life, or for any other application in which the failure of the Motorola product could create a situation where personal injury or death may occur. Should Buyer purchase or use Motorola products for any such unintended or unauthorized application, Buyer shall indemnify and hold Motorola and its officers, employees, subsidiaries, affiliates, and distributors harmless against all claims, costs, damages, and expenses, and reasonable attorney fees arising out of, directly or indirectly, any claim of personal injury or death associated with such unintended or unauthorized use, even if such claim alleges that Motorola was negligent regarding the design or manufacture of the part. Motorola and are registered trademarks of Motorola, Inc. Motorola, Inc. is an Equal Opportunity/Affirmative Action Employer.

**How to reach us:**

**USA/EUROPE/Locations Not Listed:** Motorola Literature Distribution; P.O. Box 5405, Denver, Colorado 80217. 1-303-675-2140 or 1-800-441-2447

**JAPAN:** Motorola Japan Ltd.; SPS, Technical Information Center, 3-20-1, Minami-Azabu, Minato-ku, Tokyo 106-8573 Japan. 81-3-3440-3569

**ASIA/PACIFIC:** Motorola Semiconductors H.K. Ltd.; Silicon Harbour Centre, 2 Dai King Street, Tai Po Industrial Estate, Tai Po, N.T., Hong Kong. 852-26668334

**Technical Information Center: 1-800-521-6274**

**HOME PAGE:** <http://www.motorola.com/semiconductors/>



**MRF6522-5/D**