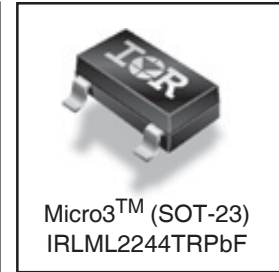
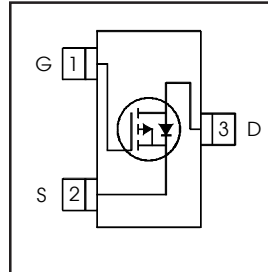


# IRLML2244TRPbF

HEXFET® Power MOSFET

$V_{DS}$	<b>-20</b>	<b>V</b>
$V_{GS}$ Max	<b>± 12</b>	<b>V</b>
$R_{DS(on)}$ max (@ $V_{GS} = -4.5V$ )	<b>54</b>	<b>mΩ</b>
$R_{DS(on)}$ max (@ $V_{GS} = -2.5V$ )	<b>95</b>	<b>mΩ</b>



## Application(s)

- System/Load Switch

## Features and Benefits

### Features

Low $R_{DS(on)}$ ( $\leq 54m\Omega$ )
Industry-standard pinout
Compatible with existing Surface Mount Techniques
RoHS compliant containing no lead, no bromide and no halogen
MSL1, Consumer qualification

results in  
⇒

### Benefits

Lower switching losses
Multi-vendor compatibility
Easier manufacturing
Environmentally friendly
Increased reliability

## Absolute Maximum Ratings

Symbol	Parameter	Max.	Units
$V_{DS}$	Drain-Source Voltage	-20	V
$I_D$ @ $T_A = 25^\circ C$	Continuous Drain Current, $V_{GS}$ @ -4.5V	-4.3	A
$I_D$ @ $T_A = 70^\circ C$	Continuous Drain Current, $V_{GS}$ @ -4.5V	-3.4	
$I_{DM}$	Pulsed Drain Current	-18	
$P_D$ @ $T_A = 25^\circ C$	Maximum Power Dissipation	1.3	W
$P_D$ @ $T_A = 70^\circ C$	Maximum Power Dissipation	0.8	
	Linear Derating Factor	0.01	
$V_{GS}$	Gate-to-Source Voltage	± 12	V
$T_J, T_{STG}$	Junction and Storage Temperature Range	-55 to + 150	°C

## Thermal Resistance

Symbol	Parameter	Typ.	Max.	Units
$R_{\theta JA}$	Junction-to-Ambient ③	—	100	°C/W
$R_{\theta JA}$	Junction-to-Ambient (t<10s) ④	—	99	

### ORDERING INFORMATION:

See detailed ordering and shipping information on the last page of this data sheet.

Notes ① through ④ are on page 10  
www.irf.com


# IRLML2244TRPbF

International  
IR Rectifier

## Electric Characteristics @ $T_J = 25^\circ\text{C}$ (unless otherwise specified)

Symbol	Parameter	Min.	Typ.	Max.	Units	Conditions
$V_{(BR)DSS}$	Drain-to-Source Breakdown Voltage	-20	—	—	V	$V_{GS} = 0V, I_D = -250\mu A$
$\Delta V_{(BR)DSS}/\Delta T_J$	Breakdown Voltage Temp. Coefficient	—	0.01	—	V/ $^\circ\text{C}$	Reference to $25^\circ\text{C}, I_D = -1\text{mA}$
$R_{DS(on)}$	Static Drain-to-Source On-Resistance	—	42	54	m $\Omega$	$V_{GS} = -4.5V, I_D = -4.3A$ ②
		—	71	95		$V_{GS} = -2.5V, I_D = -3.4A$ ②
$V_{GS(th)}$	Gate Threshold Voltage	-0.4	—	-1.1	V	$V_{DS} = V_{GS}, I_D = -10\mu A$
$I_{DSS}$	Drain-to-Source Leakage Current	—	—	1	$\mu A$	$V_{DS} = -16V, V_{GS} = 0V$
		—	—	150		$V_{DS} = -16V, V_{GS} = 0V, T_J = 125^\circ\text{C}$
$I_{GSS}$	Gate-to-Source Forward Leakage	—	—	-100	nA	$V_{GS} = 12V$
	Gate-to-Source Reverse Leakage	—	—	100		$V_{GS} = -12V$
$R_G$	Internal Gate Resistance	—	8.9	—	$\Omega$	
$g_{fs}$	Forward Transconductance	6.5	—	—	S	$V_{DS} = -10V, I_D = -4.3A$
$Q_g$	Total Gate Charge	—	6.9	—	nC	$I_D = -4.3A$
$Q_{gs}$	Gate-to-Source Charge	—	1.0	—		$V_{DS} = -10V$
$Q_{gd}$	Gate-to-Drain ("Miller") Charge	—	2.9	—		$V_{GS} = -4.5V$ ②
$t_{d(on)}$	Turn-On Delay Time	—	7.0	—	ns	$V_{DD} = -10V$ ②
$t_r$	Rise Time	—	12	—		$I_D = -1A$
$t_{d(off)}$	Turn-Off Delay Time	—	34	—		$R_G = 6.8\Omega$
$t_f$	Fall Time	—	25	—		$V_{GS} = -4.5V$
$C_{iss}$	Input Capacitance	—	570	—	pF	$V_{GS} = 0V$
$C_{oss}$	Output Capacitance	—	160	—		$V_{DS} = -16V$
$C_{rss}$	Reverse Transfer Capacitance	—	110	—		$f = 1.0\text{KHz}$

## Source - Drain Ratings and Characteristics

Symbol	Parameter	Min.	Typ.	Max.	Units	Conditions
$I_S$	Continuous Source Current (Body Diode)	—	—	-1.3	A	MOSFET symbol showing the integral reverse p-n junction diode. 
$I_{SM}$	Pulsed Source Current (Body Diode) ①	—	—	-18		
$V_{SD}$	Diode Forward Voltage	—	—	-1.2	V	$T_J = 25^\circ\text{C}, I_S = -4.3A, V_{GS} = 0V$ ②
$t_{rr}$	Reverse Recovery Time	—	21	32	ns	$T_J = 25^\circ\text{C}, V_R = -16V, I_F = -4.3A$
$Q_{rr}$	Reverse Recovery Charge	—	9.0	14	nC	$di/dt = 100A/\mu s$ ②

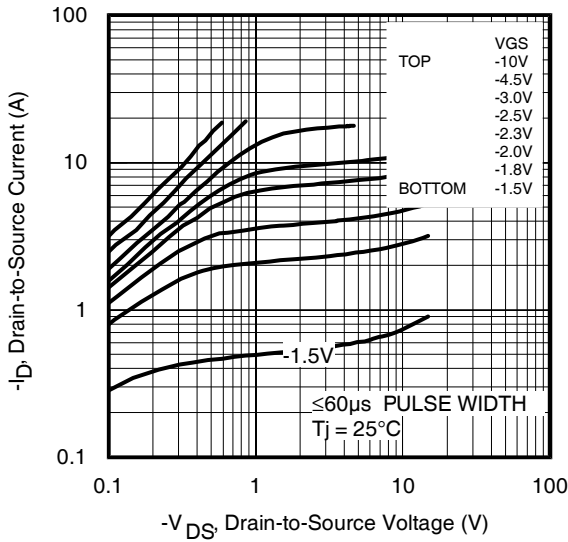


Fig 1. Typical Output Characteristics

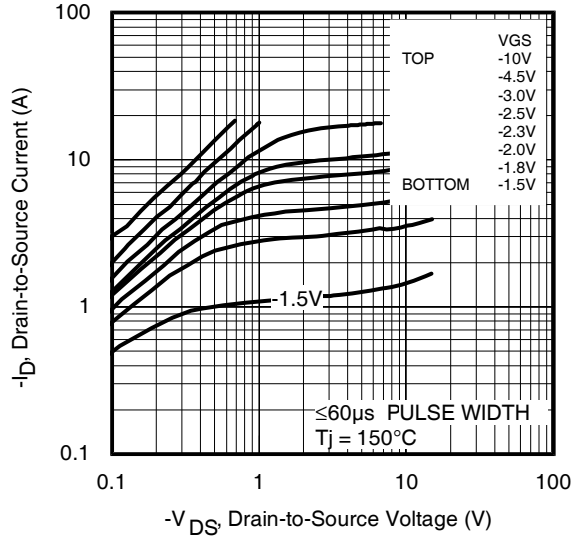


Fig 2. Typical Output Characteristics

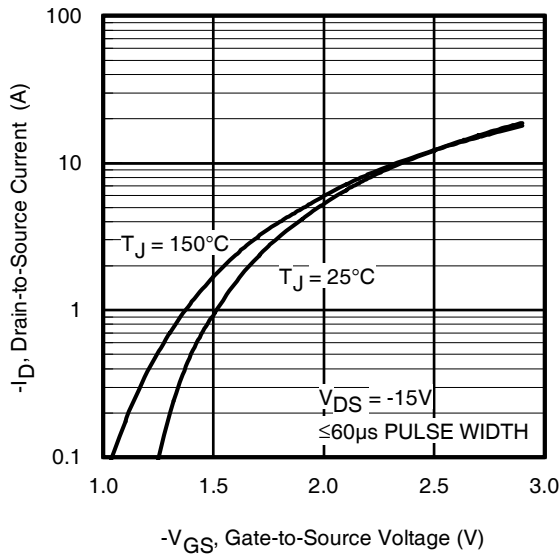


Fig 3. Typical Transfer Characteristics

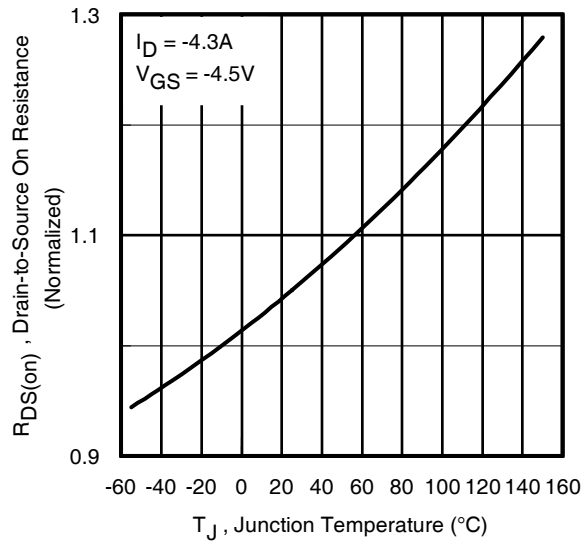
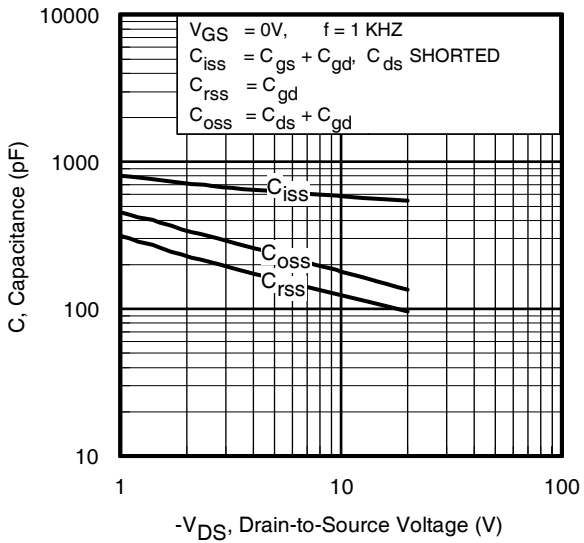
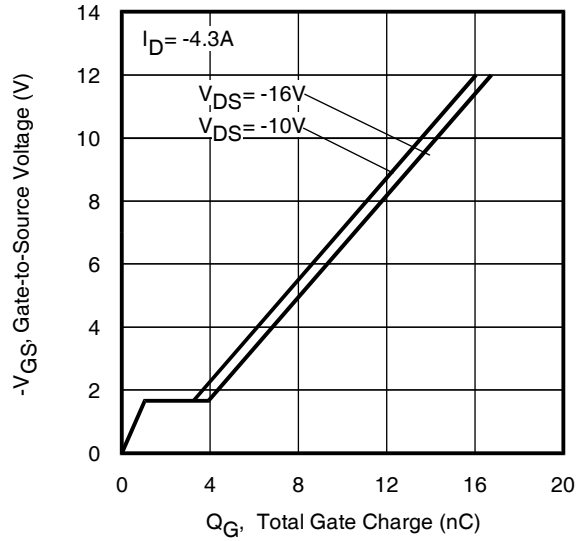


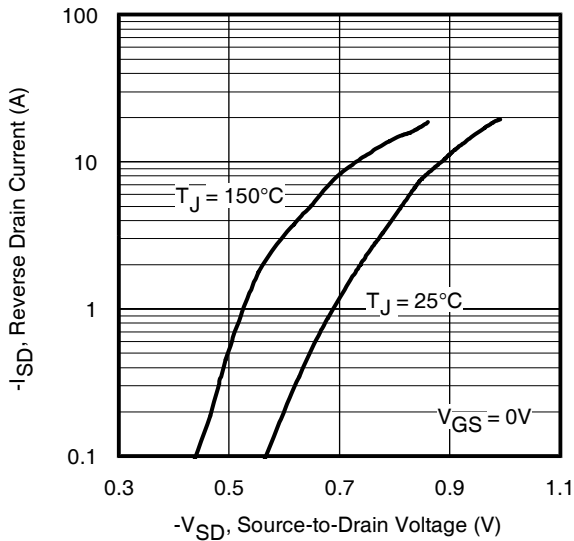
Fig 4. Normalized On-Resistance Vs. Temperature



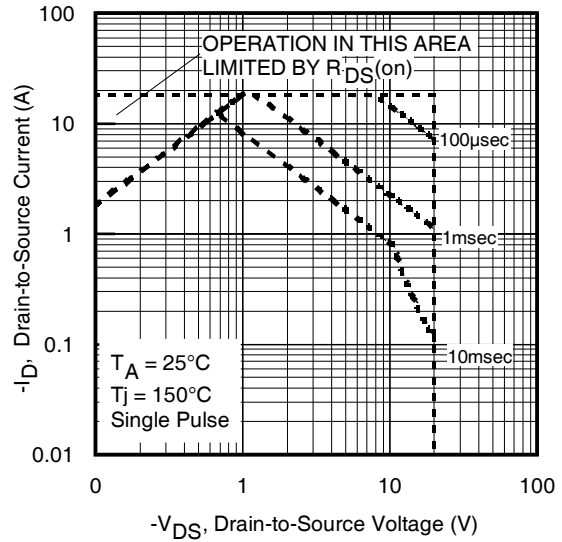
**Fig 5.** Typical Capacitance Vs. Drain-to-Source Voltage



**Fig 6.** Typical Gate Charge Vs. Gate-to-Source Voltage

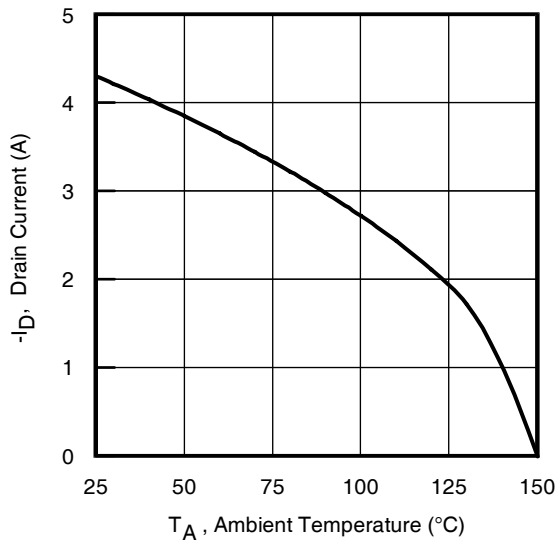


**Fig 7.** Typical Source-Drain Diode Forward Voltage

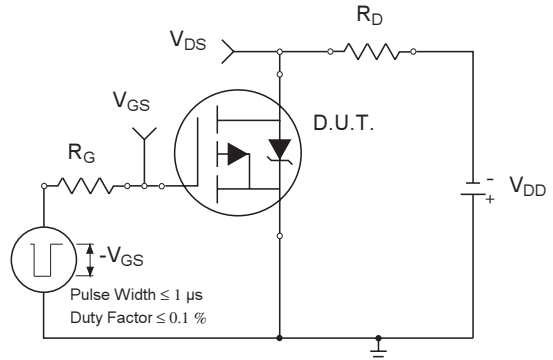


**Fig 8.** Maximum Safe Operating Area

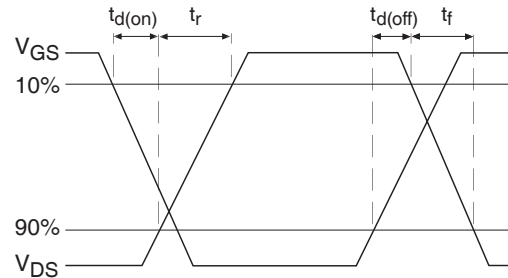
# IRLML2244TRPbF



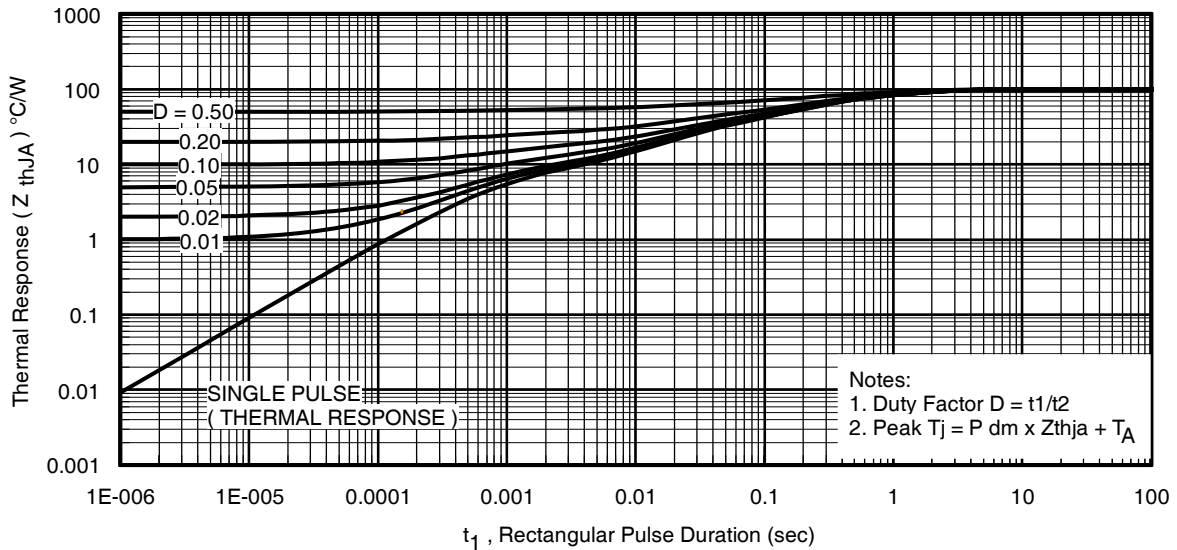
**Fig 9.** Maximum Drain Current Vs. Ambient Temperature



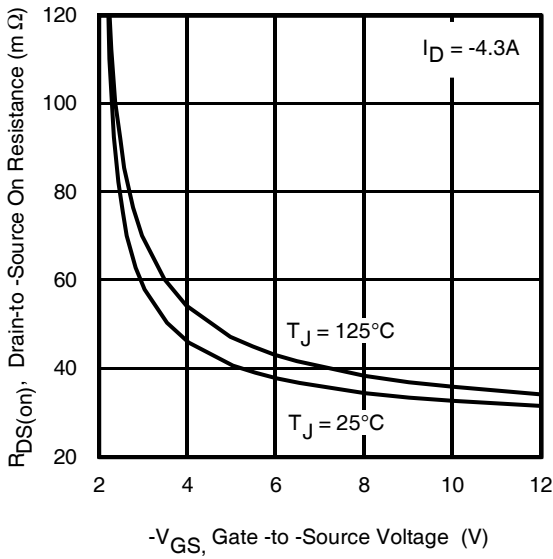
**Fig 10a.** Switching Time Test Circuit



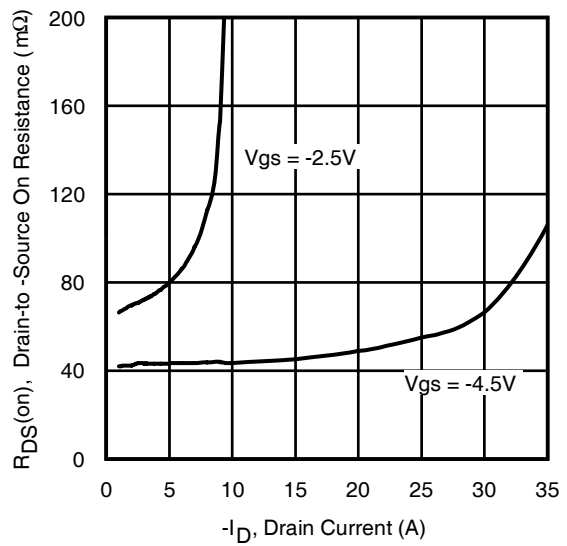
**Fig 10b.** Switching Time Waveforms



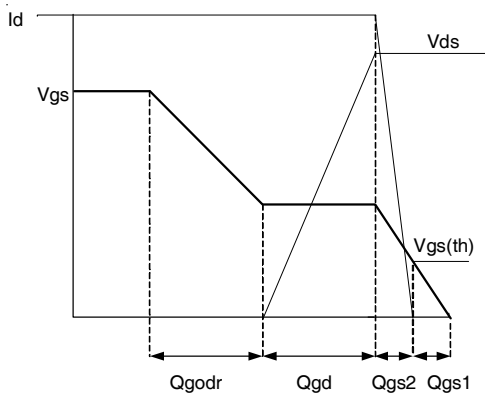
**Fig 11.** Typical Effective Transient Thermal Impedance, Junction-to-Ambient



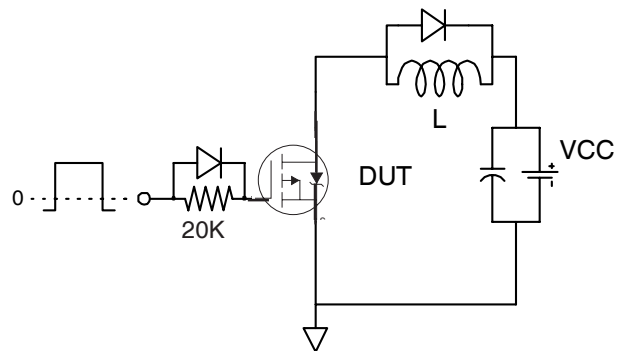
**Fig 12.** Typical On-Resistance Vs. Gate Voltage



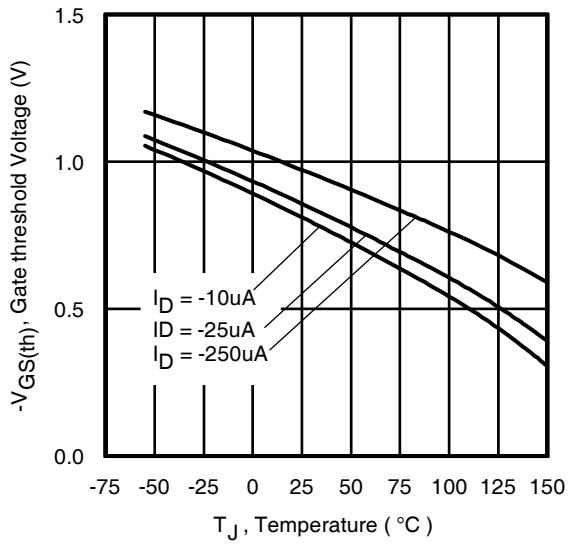
**Fig 13.** Typical On-Resistance Vs. Drain Current



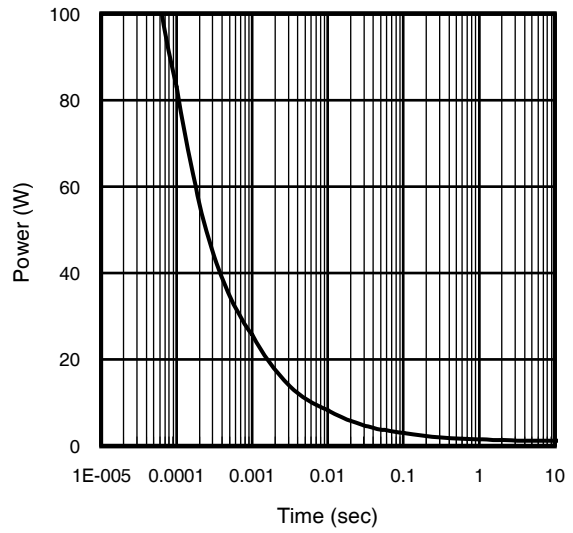
**Fig 14a.** Basic Gate Charge Waveform



**Fig 14b.** Gate Charge Test Circuit



**Fig 15.** Typical Threshold Voltage Vs. Junction Temperature



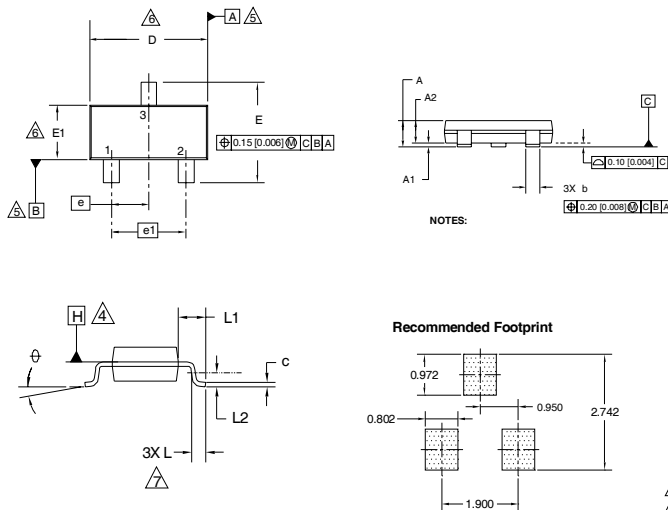
**Fig 16.** Typical Power Vs. Time

# IRLML2244TRPbF

International  
**IR** Rectifier

## Micro3 (SOT-23) Package Outline

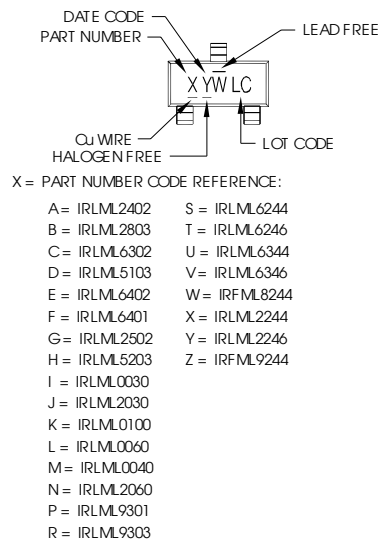
Dimensions are shown in millimeters (inches)



SYMBOL	MILLIMETERS		INCHES	
	MIN	MAX	MIN	MAX
A	0.89	1.12	0.035	0.044
A1	0.01	0.10	0.0004	0.004
A2	0.88	1.02	0.035	0.040
b	0.30	0.50	0.012	0.020
c	0.08	0.20	0.003	0.008
D	2.80	3.04	0.110	0.120
E	2.10	2.64	0.083	0.104
E1	1.20	1.40	0.047	0.055
e	0.95	BSC	0.037	BSC
e1	1.90	BSC	0.075	BSC
L	0.40	0.60	0.016	0.024
L1	0.54	REF	0.021	REF
L2	0.25	BSC	0.010	BSC
⌀	0	8	0	8

1. DIMENSIONING & TOLERANCING PER ANSI Y14.5M-1994
2. DIMENSIONS ARE SHOWN IN MILLIMETERS (INCHES)
3. CONTROLLING DIMENSION: MILLIMETER
4. DATUM PLANE H IS LOCATED AT THE MOLD PARTING LINE
5. DATUM A AND B TO BE DETERMINED AT DATUM PLANE H
6. DIMENSIONS D AND E1 ARE MEASURED AT DATUM PLANE H. DIMENSIONS DOES NOT INCLUDE MOLD PROTRUSIONS OR INTERLEAD FLASH. MOLD PROTRUSIONS OR INTERLEAD FLASH SHALL NOT EXCEED 0.25 MM [0.010 INCH] PER SIDE
7. DIMENSION L IS THE LEAD LENGTH FOR SOLDERING TO A SUBSTRATE
8. OUTLINE CONFORMS TO JEDEC OUTLINE TO-236 AB

## Micro3 (SOT-23/TO-236AB) Part Marking Information



X = PART NUMBER CODE REFERENCE:

A = IRLML2402	S = IRLML6244
B = IRLML2803	T = IRLML6246
C = IRLML6302	U = IRLML6344
D = IRLML5103	V = IRLML6346
E = IRLML6402	W = IRLML8244
F = IRLML6401	X = IRLML2244
G = IRLML2502	Y = IRLML2246
H = IRLML5203	Z = IRLML9244
I = IRLML0030	
J = IRLML2030	
K = IRLML0100	
L = IRLML0060	
M = IRLML0040	
N = IRLML2060	
P = IRLML9301	
R = IRLML9303	

Note: A line above the work week (as shown here) indicates Lead-Free.

W = (1-26) IF PRECEDED BY LAST DIGIT OF CALENDAR YEAR

YEAR	Y	WORK WEEK	W
2001	1	01	A
2002	2	02	B
2003	3	03	C
2004	4	04	D
2005	5		
2006	6		
2007	7		
2008	8		
2009	9		
2010	0	24	X
		25	Y
		26	Z

W = (27-52) IF PRECEDED BY A LETTER

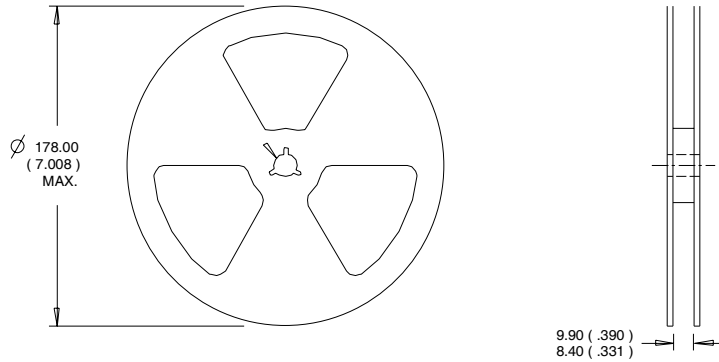
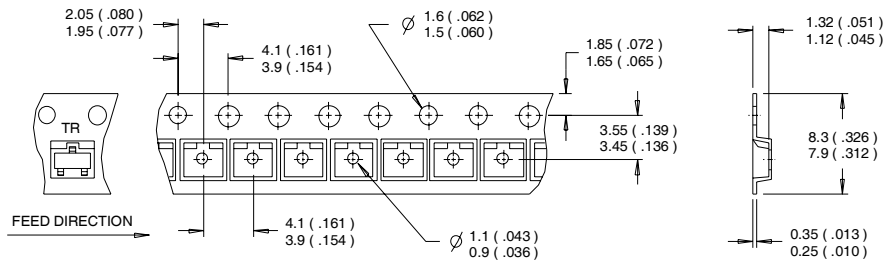
YEAR	Y	WORK WEEK	W
2001	A	27	A
2002	B	28	B
2003	C	29	C
2004	D	30	D
2005	E		
2006	F		
2007	G		
2008	H		
2009	J		
2010	K	50	X
		51	Y
		52	Z

Note: For the most current drawing please refer to IR website at: <http://www.irf.com/package/>



## Micro3™ Tape & Reel Information

Dimensions are shown in millimeters (inches)



- NOTES:
1. CONTROLLING DIMENSION : MILLIMETER.
  2. OUTLINE CONFORMS TO EIA-481 & EIA-541.

Note: For the most current drawing please refer to IR website at: <http://www.irf.com/package/>  
[www.irf.com](http://www.irf.com)

# IRLML2244TRPbF

International  
**IOR** Rectifier

Orderable part number	Package Type	Standard Pack		Note
		Form	Quantity	
IRLML2244TRPbF	Micro3	Tape and Reel	3000	

## Qualification information<sup>†</sup>

Qualification level	Consumer <sup>††</sup> (per JEDEC JESD47F <sup>†††</sup> guidelines)		
Moisture Sensitivity Level	Micro3	MSL1 (per IPC/JEDEC J-STD-020D <sup>†††</sup> )	
RoHS compliant	Yes		

- † Qualification standards can be found at International Rectifier's web site  
<http://www.irf.com/product-info/reliability>
- †† Higher qualification ratings may be available should the user have such requirements.  
 Please contact your International Rectifier sales representative for further information:  
<http://www.irf.com/whoto-call/salesrep/>
- ††† Applicable version of JEDEC standard at the time of product release.

## Notes:

- ① Repetitive rating; pulse width limited by max. junction temperature.
- ② Pulse width  $\leq 400\mu\text{s}$ ; duty cycle  $\leq 2\%$ .
- ③ Surface mounted on 1 in square Cu board
- ④ Refer to [application note #AN-994](#).

Data and specifications subject to change without notice.

International  
**IOR** Rectifier

**IR WORLD HEADQUARTERS:** 233 Kansas St., El Segundo, California 90245, USA Tel: (310) 252-7105  
 TAC Fax: (310) 252-7903

Visit us at [www.irf.com](http://www.irf.com) for sales contact information.01/2011