

SMPS MOSFET

IRFR430A
IRFU430A

HEXFET® Power MOSFET

Applications

- Switch Mode Power Supply (SMPS)
- Uninterruptible Power Supply
- High speed power switching

V_{DSS}	R_{DS(on)} max	I_D
500V	1.7Ω	5.0A

Benefits

- Low Gate Charge Qg results in Simple Drive Requirement
- Improved Gate, Avalanche and dynamic dv/dt Ruggedness
- Fully Characterized Capacitance and Avalanche Voltage and Current
- Effective C_{OSS} specified (See AN 1001)

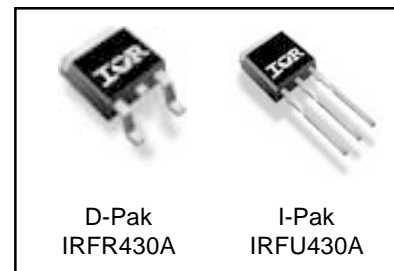

Absolute Maximum Ratings

	Parameter	Max.	Units
I _D @ T _C = 25°C	Continuous Drain Current, V _{GS} @ 10V	5.0	A
I _D @ T _C = 100°C	Continuous Drain Current, V _{GS} @ 10V	3.2	
I _{DM}	Pulsed Drain Current ①	20	
P _D @ T _C = 25°C	Power Dissipation	110	W
	Linear Derating Factor	0.91	W/°C
V _{GS}	Gate-to-Source Voltage	± 30	V
dv/dt	Peak Diode Recovery dv/dt ③	3.0	V/ns
T _J	Operating Junction and	-55 to + 150	
T _{STG}	Storage Temperature Range		
	Soldering Temperature, for 10 seconds		

Avalanche Characteristics

	Parameter	Typ.	Max.	Units
E _{AS}	Single Pulse Avalanche Energy②	—	130	mJ
I _{AR}	Avalanche Current①	—	5.0	A
E _{AR}	Repetitive Avalanche Energy①	—	11	mJ

Thermal Resistance

	Parameter	Typ.	Max.	Units
R _{θJC}	Junction-to-Case	—	1.1	°C/W
R _{θCS}	Case-to-Sink, Flat, Greased Surface	0.50	—	
R _{θJA}	Junction-to-Ambient	—	62	

IRFR430A/IRFU430A

International
IR Rectifier

Static @ $T_J = 25^\circ\text{C}$ (unless otherwise specified)

	Parameter	Min.	Typ.	Max.	Units	Conditions
$V_{(BR)DSS}$	Drain-to-Source Breakdown Voltage	500	—	—	V	$V_{GS} = 0V, I_D = 250\mu A$
$\Delta V_{(BR)DSS}/\Delta T_J$	Breakdown Voltage Temp. Coefficient	—	0.60	—	V/°C	Reference to $25^\circ\text{C}, I_D = 1\text{mA}$
$R_{DS(on)}$	Static Drain-to-Source On-Resistance	—	—	1.7	Ω	$V_{GS} = 10V, I_D = 3.0A$ ④
$V_{GS(th)}$	Gate Threshold Voltage	2.0	—	4.5	V	$V_{DS} = V_{GS}, I_D = 250\mu A$
I_{DSS}	Drain-to-Source Leakage Current	—	—	25	μA	$V_{DS} = 500V, V_{GS} = 0V$
		—	—	250		$V_{DS} = 400V, V_{GS} = 0V, T_J = 125^\circ\text{C}$
I_{GSS}	Gate-to-Source Forward Leakage	—	—	100	nA	$V_{GS} = 30V$
	Gate-to-Source Reverse Leakage	—	—	-100		$V_{GS} = -30V$

Dynamic @ $T_J = 25^\circ\text{C}$ (unless otherwise specified)

	Parameter	Min.	Typ.	Max.	Units	Conditions
g_{fs}	Forward Transconductance	2.3	—	—	S	$V_{DS} = 50V, I_D = 3.0A$
Q_g	Total Gate Charge	—	—	24	nC	$I_D = 5.0A$
Q_{gs}	Gate-to-Source Charge	—	—	6.5		$V_{DS} = 400V$
Q_{gd}	Gate-to-Drain ("Miller") Charge	—	—	13		$V_{GS} = 10V, \text{See Fig. 6 and 13}$ ④
$t_{d(on)}$	Turn-On Delay Time	—	8.7	—	ns	$V_{DD} = 250V$
t_r	Rise Time	—	27	—		$I_D = 5.0A$
$t_{d(off)}$	Turn-Off Delay Time	—	17	—		$R_G = 15\Omega$
t_f	Fall Time	—	16	—		$R_D = 50\Omega, \text{See Fig. 10}$ ④
C_{iss}	Input Capacitance	—	490	—	pF	$V_{GS} = 0V$
C_{oss}	Output Capacitance	—	75	—		$V_{DS} = 25V$
C_{rSS}	Reverse Transfer Capacitance	—	4.5	—		$f = 1.0\text{MHz}, \text{See Fig. 5}$
C_{oss}	Output Capacitance	—	750	—		$V_{GS} = 0V, V_{DS} = 1.0V, f = 1.0\text{MHz}$
C_{oss}	Output Capacitance	—	25	—		$V_{GS} = 0V, V_{DS} = 400V, f = 1.0\text{MHz}$
$C_{oss \text{ eff.}}$	Effective Output Capacitance	—	51	—		$V_{GS} = 0V, V_{DS} = 0V \text{ to } 400V$ ⑤

Diode Characteristics

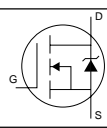
	Parameter	Min.	Typ.	Max.	Units	Conditions
I_S	Continuous Source Current (Body Diode)	—	—	5.0	A	MOSFET symbol showing the integral reverse p-n junction diode. 
I_{SM}	Pulsed Source Current (Body Diode) ①	—	—	20		
V_{SD}	Diode Forward Voltage	—	—	1.5	V	$T_J = 25^\circ\text{C}, I_S = 5.0A, V_{GS} = 0V$ ④
t_{rr}	Reverse Recovery Time	—	410	620	ns	$T_J = 25^\circ\text{C}, I_F = 5.0A$
Q_{rr}	Reverse Recovery Charge	—	1.4	2.1	μC	$di/dt = 100A/\mu s$ ④
t_{on}	Forward Turn-On Time	Intrinsic turn-on time is negligible (turn-on is dominated by $L_S + L_D$)				

Notes:

- ① Repetitive rating; pulse width limited by max. junction temperature. (See fig. 11)
- ② Starting $T_J = 25^\circ\text{C}, L = 11\text{mH}$
 $R_G = 25\Omega, I_{AS} = 5.0A.$ (See Figure 12)
- ③ $I_{SD} \leq 5.0A, di/dt \leq 320A/\mu s, V_{DD} \leq V_{(BR)DSS}, T_J \leq 150^\circ\text{C}.$

④ Pulse width $\leq 300\mu s$; duty cycle $\leq 2\%$.

⑤ $C_{oss \text{ eff.}}$ is a fixed capacitance that gives the same charging time as C_{oss} while V_{DS} is rising from 0 to 80% V_{DSS} .

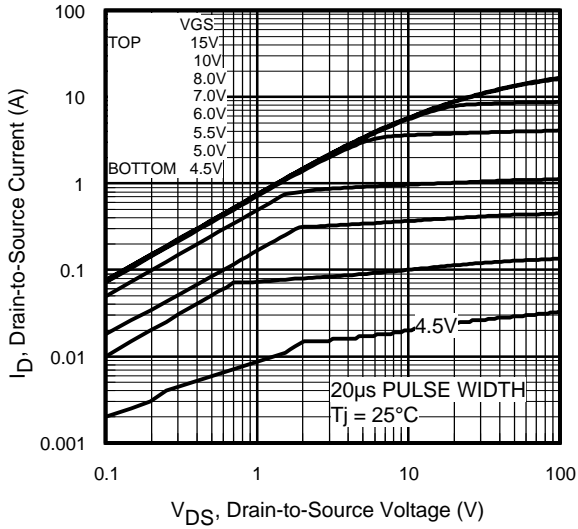

Fig 1. Typical Output Characteristics

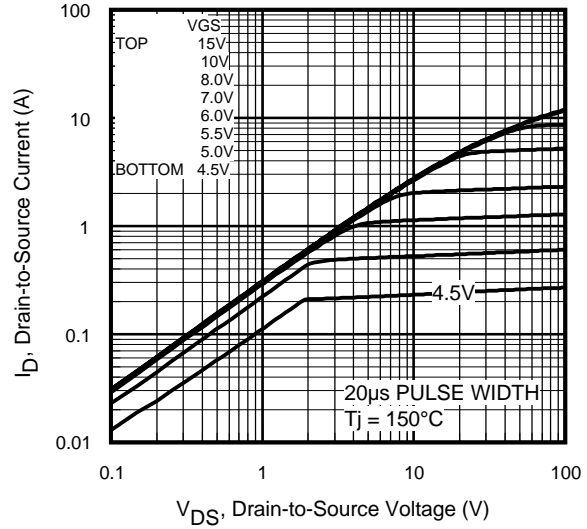

Fig 2. Typical Output Characteristics

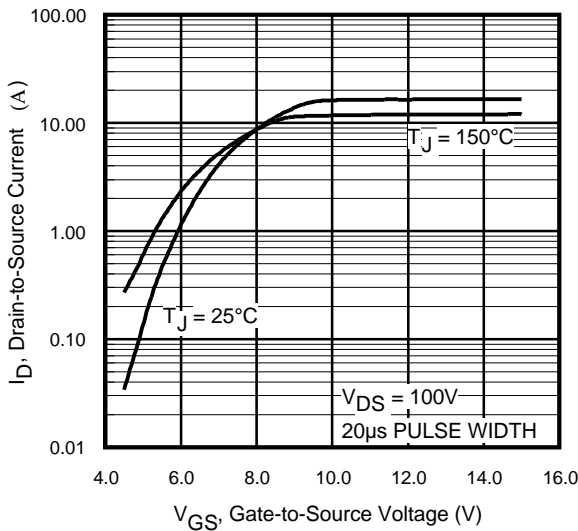

Fig 3. Typical Transfer Characteristics

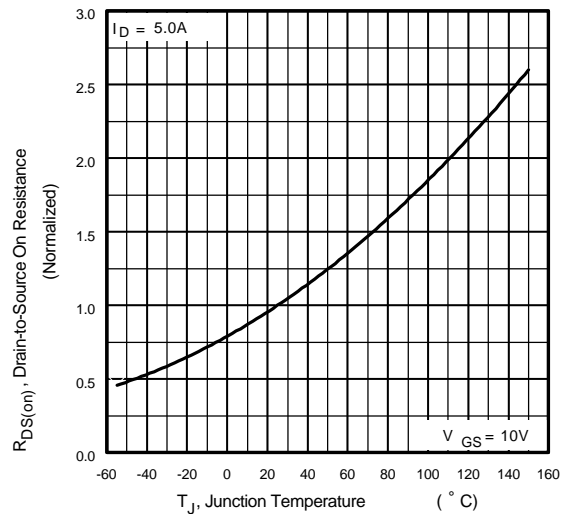

Fig 4. Normalized On-Resistance Vs. Temperature

IRFR430A/IRFU430A

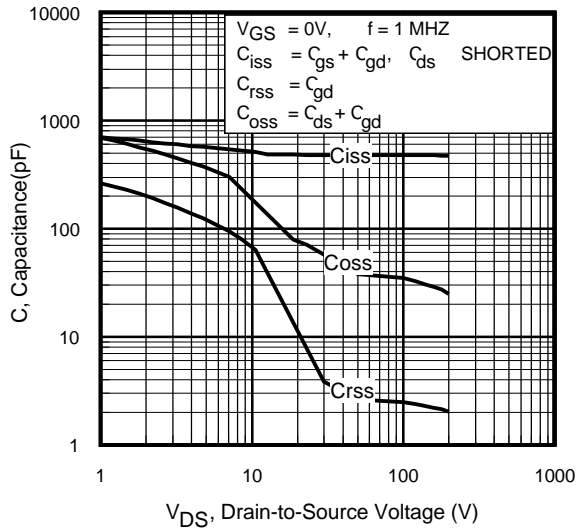

Fig 5. Typical Capacitance Vs. Drain-to-Source Voltage

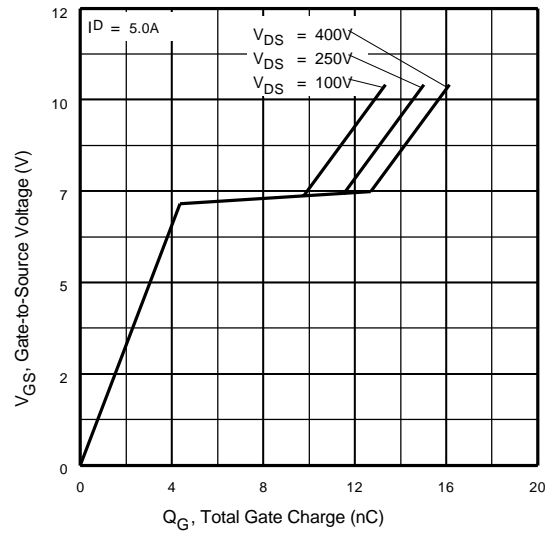

Fig 6. Typical Gate Charge Vs. Gate-to-Source Voltage

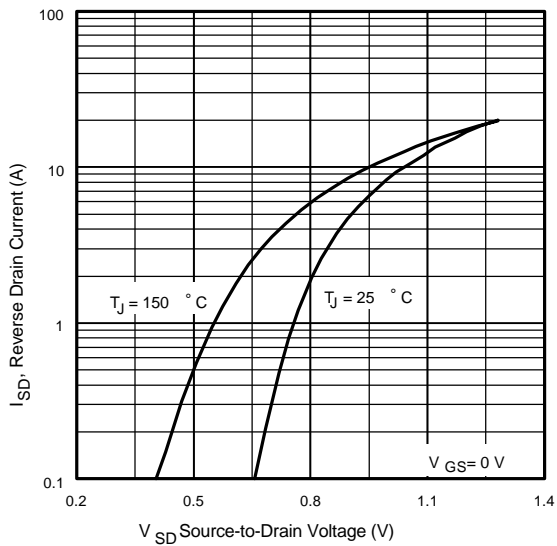

Fig 7. Typical Source-Drain Diode Forward Voltage

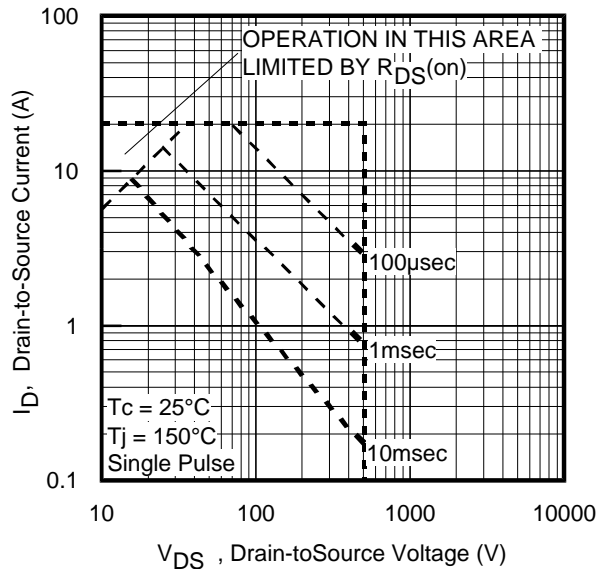

Fig 8. Maximum Safe Operating Area

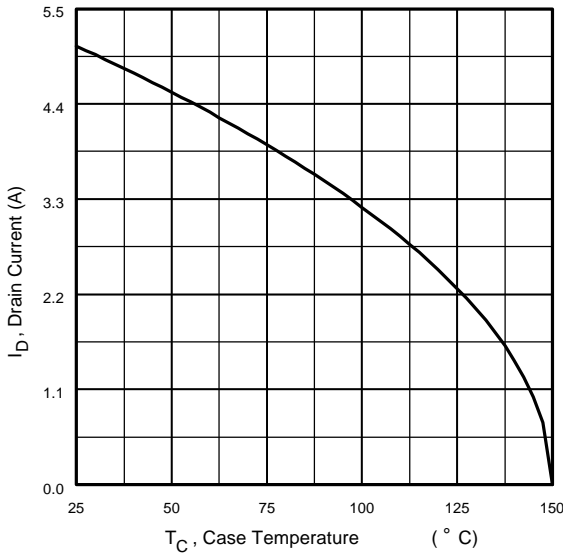

Fig 9. Maximum Drain Current Vs. Case Temperature

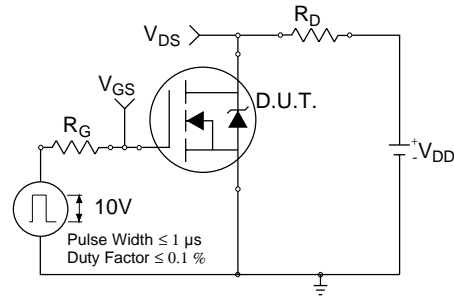

Fig 10a. Switching Time Test Circuit



Fig 10b. Switching Time Waveforms

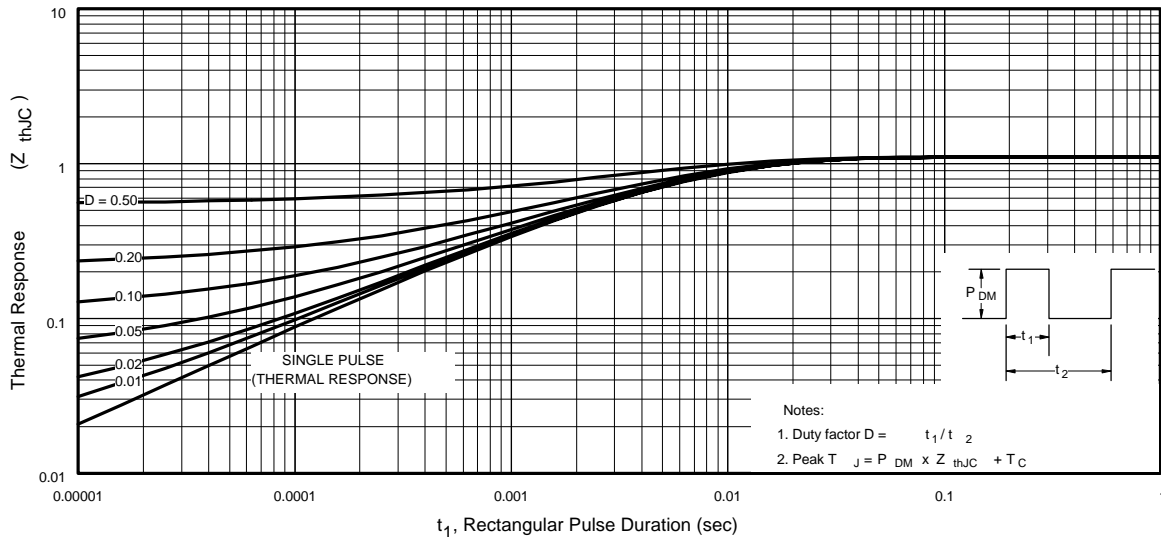

Fig 11. Maximum Effective Transient Thermal Impedance, Junction-to-Case

IRFR430A/IRFU430A

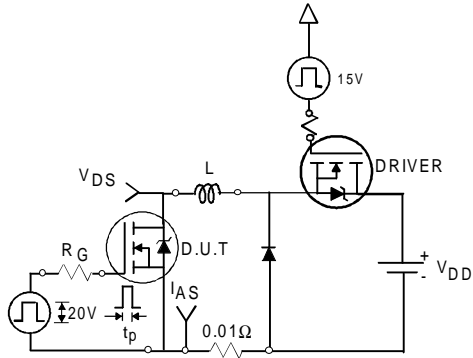

Fig 12a. Unclamped Inductive Test Circuit

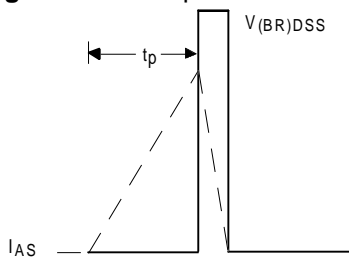

Fig 12b. Unclamped Inductive Waveforms

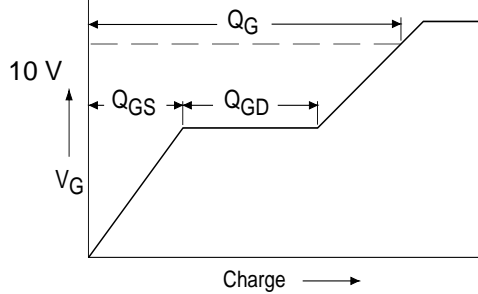

Fig 13a. Basic Gate Charge Waveform

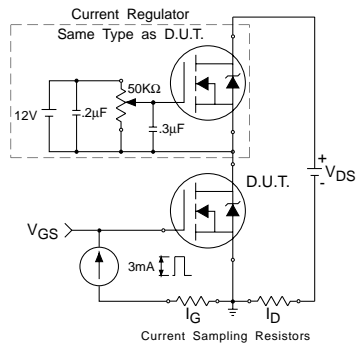

Fig 13b. Gate Charge Test Circuit

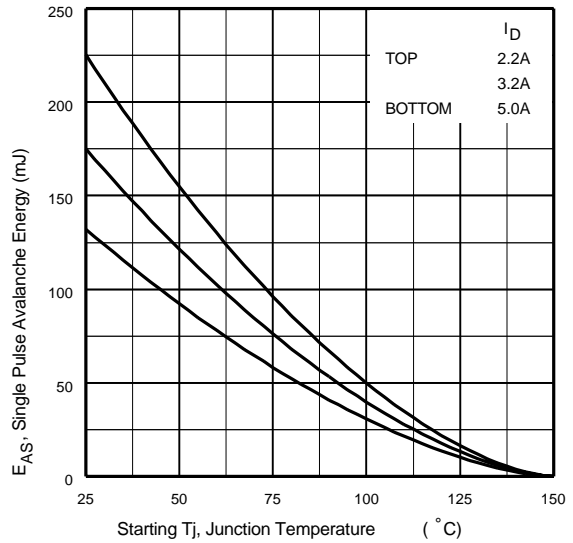

Fig 12c. Maximum Avalanche Energy Vs. Drain Current

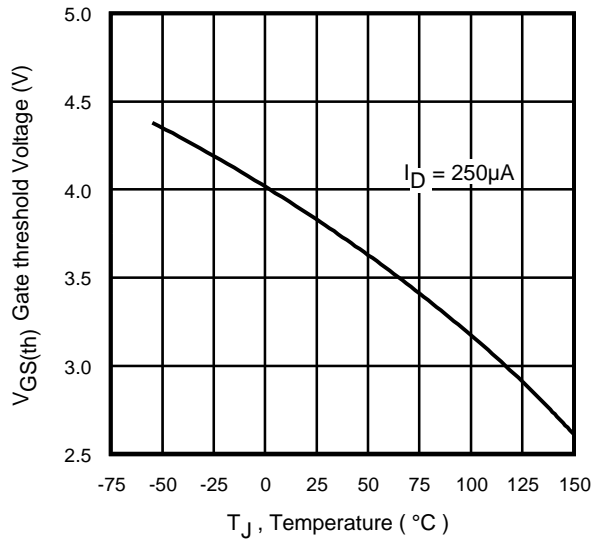
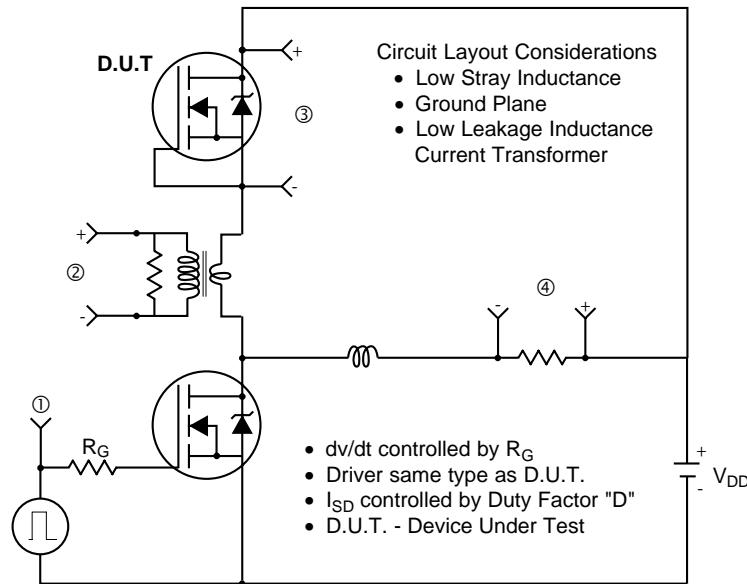

Fig 14. Threshold Voltage Vs. Temperature

Peak Diode Recovery dv/dt Test Circuit



* $V_{GS} = 5V$ for Logic Level Devices

Fig 14. For N-Channel HEXFET® Power MOSFETs

IRFR430A/IRFU430A

International
IR Rectifier

D-Pak (TO-252AA) Package Outline

Dimensions are shown in millimeters (inches)

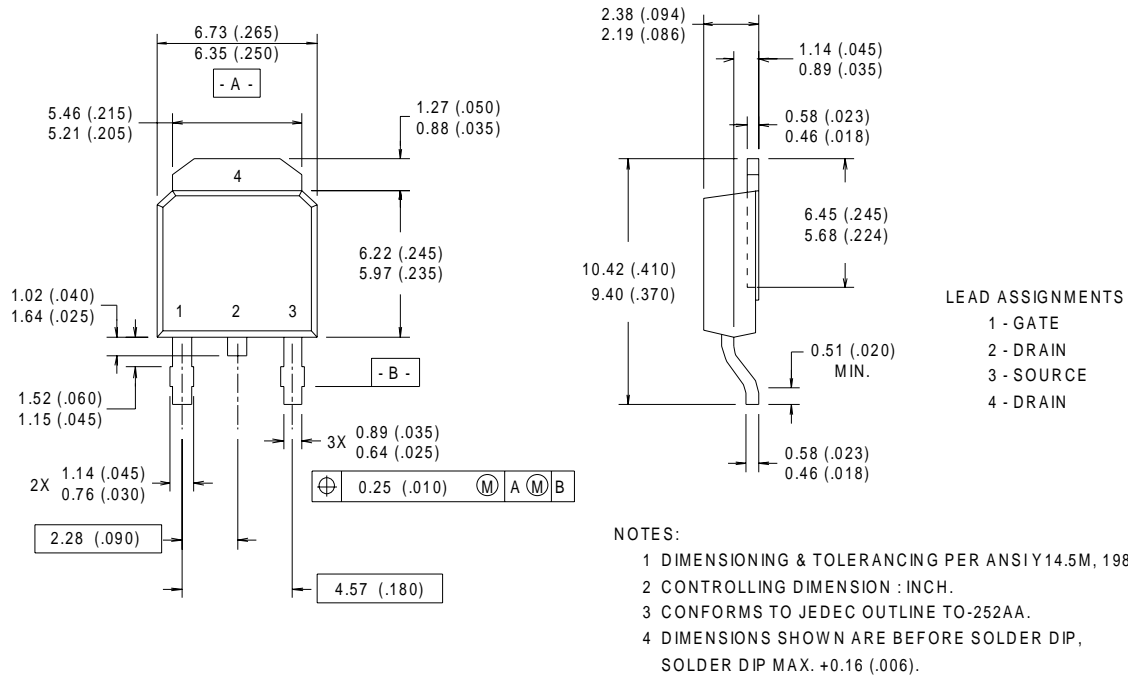

D-Pak (TO-252AA) Part Marking Information

EXAMPLE: THIS IS AN IRFR120
WITH ASSEMBLY
LOT CODE 1234
ASSEMBLED ON WW 16, 1999
IN THE ASSEMBLY LINE "A"

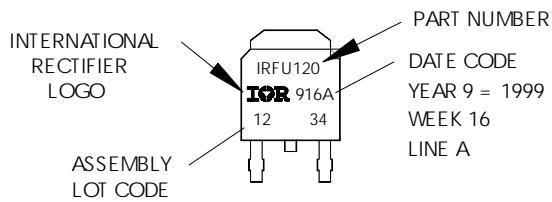

I-Pak (TO-251AA) Package Outline

Dimensions are shown in millimeters (inches)

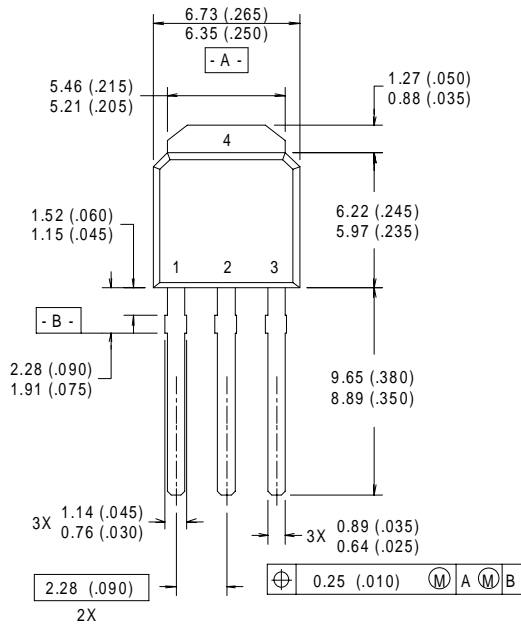

LEAD ASSIGNMENTS

- 1 - GATE
- 2 - DRAIN
- 3 - SOURCE
- 4 - DRAIN

NOTES:

- 1 DIMENSIONING & TOLERANCING PER ANSI Y14.5M, 1982.
- 2 CONTROLLING DIMENSION : INCH.
- 3 CONFORMS TO JEDEC OUTLINE TO-252AA.
- 4 DIMENSIONS SHOWN ARE BEFORE SOLDER DIP, SOLDER DIP MAX. +0.16 (.006).

I-Pak (TO-251AA) Part Marking Information

EXAMPLE: THIS IS AN IRFR120
 WITH ASSEMBLY
 LOT CODE 5678
 ASSEMBLED ON WW 19, 1999
 IN THE ASSEMBLY LINE "A"

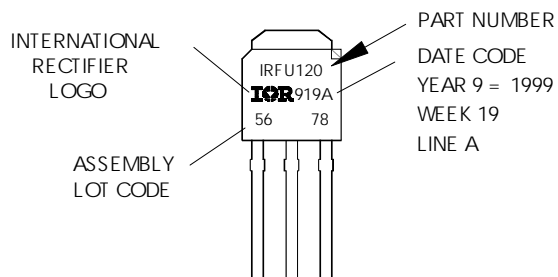

IRFR430A/IRFU430A

International
IR Rectifier

D-Pak (TO-252AA) Tape & Reel Information

Dimensions are shown in millimeters (inches)

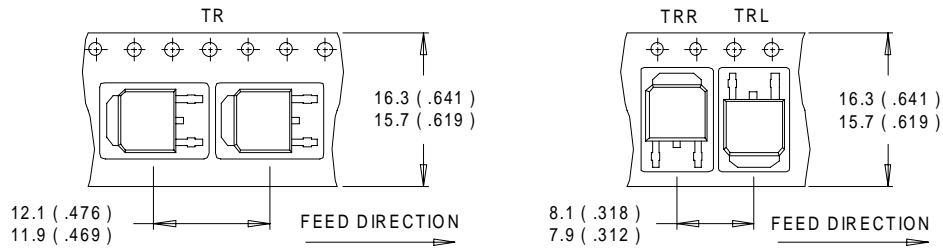

NOTES :

1. CONTROLLING DIMENSION : MILLIMETER.
2. ALL DIMENSIONS ARE SHOWN IN MILLIMETERS (INCHES).
3. OUTLINE CONFORMS TO EIA-481 & EIA-541.

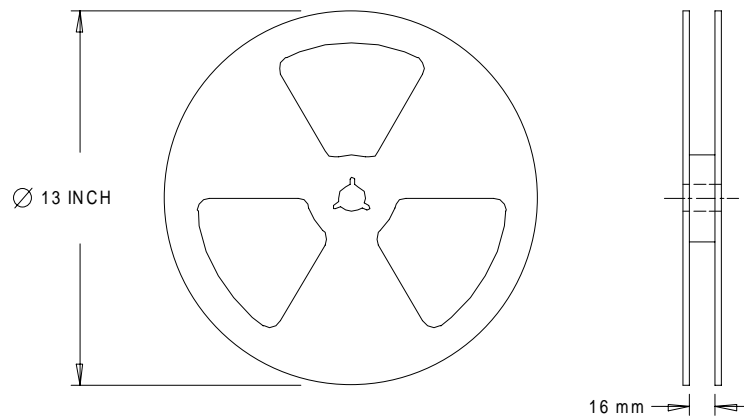

NOTES :

1. OUTLINE CONFORMS TO EIA-481.

Data and specifications subject to change without notice.
This product has been designed and qualified for the Automotive [Q101] market.
Qualification Standards can be found on IR's Web site.

International
IR Rectifier

IR WORLD HEADQUARTERS: 233 Kansas St., El Segundo, California 90245, USA Tel: (310) 252-7105
TAC Fax: (310) 252-7903

Visit us at www.irf.com for sales contact information.02/02

www.irf.com