

- N-Channel Application-Specific MOSFETs
- Ideal for CPU Core DC-DC Converters
- Low Conduction Losses
- Low Switching Losses
- Minimizes Parallel MOSFETs for high current applications

HEXFET® Chipset for DC-DC Converters

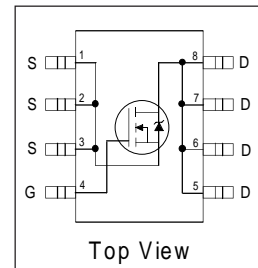
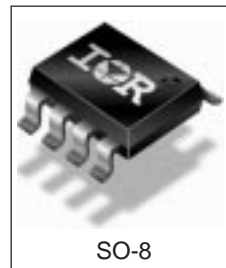

Description

These new devices employ advanced HEXFET® Power MOSFET technology to achieve an unprecedented balance of on-resistance and gate charge. The reduced conduction and switching losses make them ideal for high efficiency DC-DC converters that power the latest generation of microprocessors.

Both the IRF7809A and IRF7811A have been optimized and are 100% tested for all parameters that are critical in synchronous buck converters including $R_{DS(on)}$, gate charge and $C_{dv/dt}$ -induced turn-on immunity. The IRF7809A offers particularly low $R_{DS(on)}$ and high $C_{dv/dt}$ immunity for synchronous FET applications. The IRF7811A offers an extremely low combination of Q_{sw} & $R_{DS(on)}$ for reduced losses in control FET applications.

The package is designed for vapor phase, infra-red, convection, or wave soldering techniques. Power dissipation of greater than 2W is possible in a typical PCB mount application.

DEVICE RATINGS

	IRF7809A	IRF7811A
V_{DS}	30V	28V
$R_{DS(on)}$	8.5 mΩ	12 mΩ
Q_G	73 nC	23 nC
Q_{sw}	22.5 nC	7 nC
Q_{oss}	30 nC	31 nC

Absolute Maximum Ratings

Parameter	Symbol	IRF7809A	IRF7811A	Units
Drain-Source Voltage	V_{DS}	30	28	V
Gate-Source Voltage	V_{GS}	±12		
Continuous Drain or Source Current ($V_{GS} \geq 4.5V$)	$T_A = 25^\circ C$	14.5	11.4	A
	$T_L = 90^\circ C$	14.2	11.2	
Pulsed Drain Current①	I_{DM}	100	100	
Power Dissipation	$T_A = 25^\circ C$	2.5		W
	$T_L = 90^\circ C$	2.4		
Junction & Storage Temperature Range	T_J, T_{STG}	-55 to 150		°C
Continuous Source Current (Body Diode)	I_S	2.5	2.5	A
Pulsed Source Current①	I_{SM}	50	50	

Thermal Resistance

Parameter		Max.	Units
Maximum Junction-to-Ambient③	$R_{\theta JA}$	50	°C/W
Maximum Junction-to-Lead	$R_{\theta JL}$	25	°C/W

IRF7809A/IRF7811A

International
IR Rectifier

Electrical Characteristics		IRF7809A			IRF7811A			Units	Conditions
Parameter		Min	Typ	Max	Min	Typ	Max		
Drain-to-Source Breakdown Voltage*	BV_{DSS}	30	-	-	28	-	-	V	$V_{GS} = 0V, I_D = 250\mu A$
Static Drain-Source on Resistance*	$R_{DS(on)}$		7	8.5		10	12	m Ω	$V_{GS} = 4.5V, I_D = 15A$ ②
Gate Threshold Voltage*	$V_{GS(th)}$	1.0			1.0			V	$V_{DS} = V_{GS}, I_D = 250\mu A$
Drain-Source Leakage Current*	I_{DSS}			30			30	μA	$V_{DS} = 24V, V_{GS} = 0$
				150			150		$V_{DS} = 24V, V_{GS} = 0,$ $T_j = 100^\circ C$
Gate-Source Leakage Current*	I_{GSS}			± 100			± 100	nA	$V_{GS} = \pm 12V$
Total Gate Chg Cont FET*	Q_G		61	75		19	23	nC	$V_{GS}=5V, I_D=15A, V_{DS}=16V$
Total Gate Chg Sync FET*	Q_G		55	73		17	20.5		$V_{GS} = 5V, V_{DS} < 100mV$
Pre-Vth Gate-Source Charge	Q_{GS1}		14			2.7			$V_{DS} = 16V, I_D = 15A$
Post-Vth Gate-Source Charge	Q_{GS2}		3.5			1.3			
Gate to Drain Charge	Q_{GD}		13.5			4.5			
Switch Chg($Q_{GS2} + Q_{GD}$)*	Q_{sw}		17	22.5		5.8	7.0		
Output Charge*	Q_{oss}		25	30		26	31	Ω	$V_{DS} = 16V, V_{GS} = 0$
Gate Resistance	R_G		1.1			1.8			
Turn-on Delay Time	$t_{d(on)}$		19			8		ns	$V_{DD} = 16V, I_D = 15A$ $V_{GS} = 5V$ Clamped Inductive Load
Rise Time	t_r		9			4			
Turn-off Delay Time	$t_{d(off)}$		32			16			
Fall Time	t_f		12			8			
Input Capacitance	C_{iss}	-	7300	-	-	1800	-	pF	$V_{DS} = 16V, V_{GS} = 0$
Output Capacitance	C_{oss}	-	900	-	-	900	-		
Reverse Transfer Capacitance	C_{rss}	-	350	-	-	60	-		

Source-Drain Rating & Characteristics

Parameter		Min	Typ	Max	Min	Typ	Max	Units	Conditions
Diode Forward Voltage*	V_{SD}			1.0			1.0	V	$I_S = 15A$ ②, $V_{GS} = 0V$
Reverse Recovery Charge④	Q_{rr}		94			82		nC	$di/dt \sim 700A/\mu s$ $V_{DS} = 16V, V_{GS} = 0V, I_S = 15A$
Reverse Recovery Charge (with Parallel Schottky)④	$Q_{rr(s)}$		87			74			$di/dt = 700A/\mu s$ (with 10BQ040) $V_{DS} = 16V, V_{GS} = 0V, I_S = 15A$

Notes:

- ① Repetitive rating; pulse width limited by max. junction temperature.
 - ② Pulse width $\leq 300 \mu s$; duty cycle $\leq 2\%$.
 - ③ When mounted on 1 inch square copper board, $t < 10$ sec.
 - ④ Typ = measured - Q_{oss}
- * Devices are 100% tested to these parameters.

SO-8 Package Outline

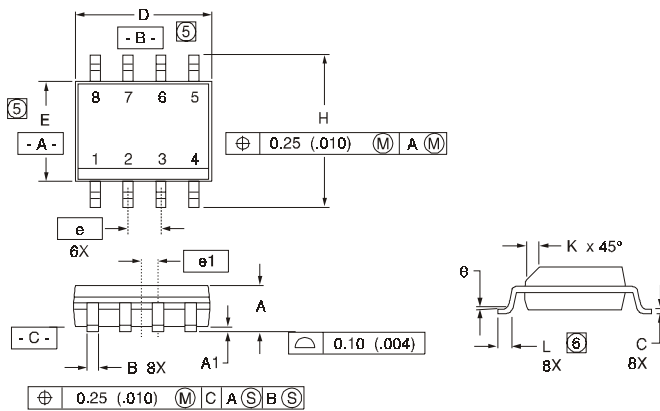

DIM	INCHES		MILLIMETERS	
	MIN	MAX	MIN	MAX
A	.0532	.0688	1.35	1.75
A1	.0040	.0098	0.10	0.25
B	.014	.018	0.36	0.46
C	.0075	.0098	0.19	0.25
D	.189	.196	4.80	4.98
E	.150	.157	3.81	3.99
e	.050 BASIC		1.27 BASIC	
e1	.025 BASIC		0.635 BASIC	
H	.2284	.2440	5.80	6.20
K	.011	.019	0.28	0.48
L	.16	.050	0.41	1.27
θ	0°	8°	0°	8°

NOTES:

1. DIMENSIONING AND TOLERANCING PER ANSI Y14.5M-1982.
2. CONTROLLING DIMENSION: INCH.
3. DIMENSIONS ARE SHOWN IN MILLIMETERS (INCHES).
4. OUTLINE CONFORMS TO JEDEC OUTLINE MS-012AA.
5. DIMENSION DOES NOT INCLUDE MOLD PROTRUSIONS
MOLD PROTRUSIONS NOT TO EXCEED 0.25 (.006).
6. DIMENSIONS IS THE LENGTH OF LEAD FOR SOLDERING TO A SUBSTRATE..

RECOMMENDED FOOTPRINT

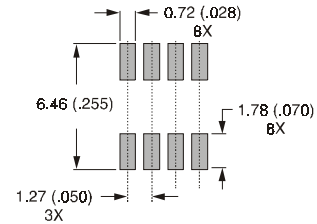

Part Marking Information

EXAMPLE: THIS IS AN IRF7101

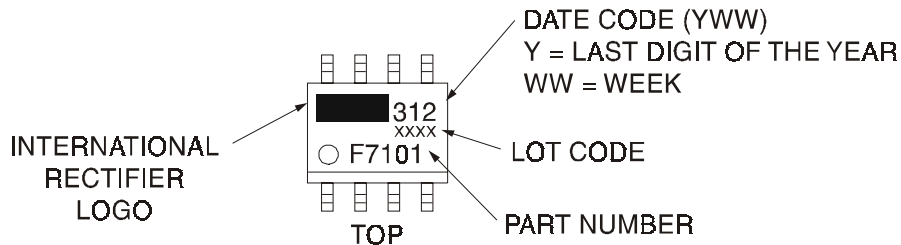

IRF7809A/IRF7811A

International
IR Rectifier

SO-8 Tape & Reel Information

Dimensions are shown in millimeters (inches)

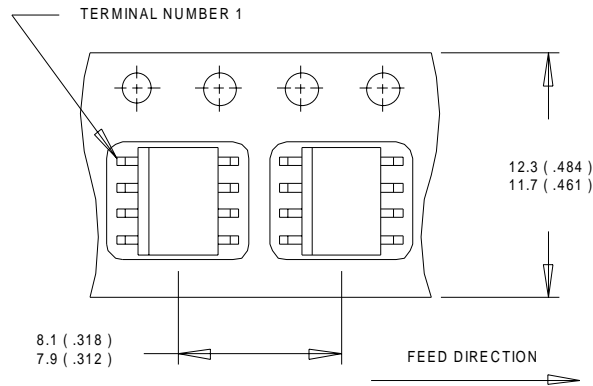

- NOTES:
1. CONTROLLING DIMENSION : MILLIMETER.
 2. ALL DIMENSIONS ARE SHOWN IN MILLIMETERS(INCHES).
 3. OUTLINE CONFORMS TO EIA-481 & EIA-541.

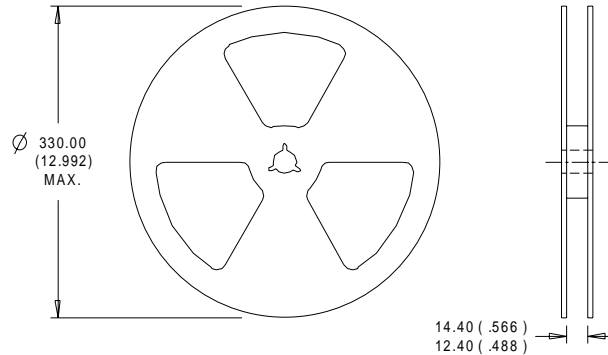

- NOTES:
1. CONTROLLING DIMENSION : MILLIMETER.
 2. OUTLINE CONFORMS TO EIA-481 & EIA-541.

International
IR Rectifier

WORLD HEADQUARTERS: 233 Kansas St., El Segundo, California 90245, Tel: (310) 252-7105

IR GREAT BRITAIN: Hurst Green, Oxted, Surrey RH8 9BB, UK Tel: ++ 44 1883 732020

IR CANADA: 15 Lincoln Court, Brampton, Ontario L6T 3Z2, Tel: (905) 453 2200

IR GERMANY: Saalburgstrasse 157, 61350 Bad Homburg Tel: ++ 49 6172 96590

IR ITALY: Via Liguria 49, 10071 Borgaro, Torino Tel: ++ 39 11 451 0111

IR JAPAN: K&H Bldg., 2F, 3-30-4 Nishi-Ikebukuro 3-Chome, Toshima-Ku, Tokyo 171-0021 Japan Tel: 81 3 3983 0086

IR SOUTHEAST ASIA: 1 Kim Seng Promenade, Great World City West Tower, 13-11, Singapore 237994 Tel: 65 838 4630

IR TAIWAN : 16F, Suite B, 319, Sec.2, Tun Hwa South Road, Taipei 10673, Taiwan, R.O.C. Tel : 886-2-2739-4230

<http://www.irf.com/> Data and specifications subject to change without notice. 1/00