

HEXFET® Power MOSFET

- Generation V Technology
- Ultra Low On-Resistance
- Dual P-Channel Mosfet
- Surface Mount
- Available in Tape & Reel
- Dynamic dv/dt Rating
- Fast Switching

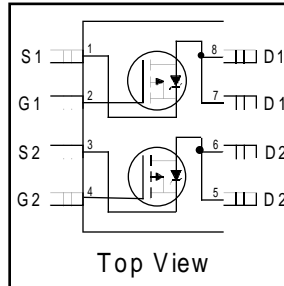

$V_{DSS} = -20V$

$R_{DS(on)} = 0.090\Omega$

Description

Fifth Generation HEXFETs from International Rectifier utilize advanced processing techniques to achieve the lowest possible on-resistance per silicon area. This benefit, combined with the fast switching speed and ruggedized device design that HEXFET Power MOSFETs are well known for, provides the designer with an extremely efficient device for use in a wide variety of applications.

The SO-8 has been modified through a customized leadframe for enhanced thermal characteristics and multiple-die capability making it ideal in a variety of power applications. With these improvements, multiple devices can be used in an application with dramatically reduced board space. The package is designed for vapor phase, infra red, or wave soldering techniques. Power dissipation of greater than 0.8W is possible in a typical PCB mount application.

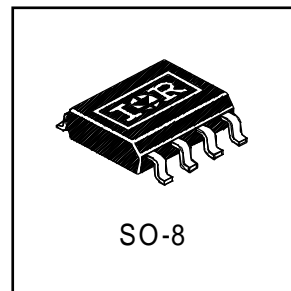

Absolute Maximum Ratings

	Parameter	Max.	Units
$I_D @ T_A = 25^\circ C$	10 Sec. Pulsed Drain Current, $V_{GS} @ -4.5V$	-4.7	A
$I_D @ T_A = 25^\circ C$	Continuous Drain Current, $V_{GS} @ -4.5V$	-4.3	
$I_D @ T_A = 70^\circ C$	Continuous Drain Current, $V_{GS} @ -4.5V$	-3.4	
I_{DM}	Pulsed Drain Current ①	-17	
$P_D @ T_A = 25^\circ C$	Power Dissipation	2.0	W
	Linear Derating Factor	0.016	W/°C
V_{GS}	Gate-to-Source Voltage	± 12	V
dv/dt	Peak Diode Recovery dv/dt ②	-5.0	V/ns
T_J, T_{STG}	Junction and Storage Temperature Range	-55 to + 150	°C

Thermal Resistance Ratings

	Parameter	Typ.	Max.	Units
$R_{\theta JA}$	Maximum Junction-to-Ambient ④	—	62.5	°C/W

Electrical Characteristics @ $T_J = 25^\circ\text{C}$ (unless otherwise specified)

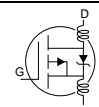
	Parameter	Min.	Typ.	Max.	Units	Conditions
$V_{(BR)DSS}$	Drain-to-Source Breakdown Voltage	-20	—	—	V	$V_{GS} = 0V, I_D = -250\mu A$
$\Delta V_{(BR)DSS}/\Delta T_J$	Breakdown Voltage Temp. Coefficient	—	-0.012	—	V/°C	Reference to $25^\circ\text{C}, I_D = -1\text{mA}$
$R_{DS(ON)}$	Static Drain-to-Source On-Resistance	—	—	0.090	Ω	$V_{GS} = -4.5V, I_D = -2.2A$ ③
		—	—	0.140		$V_{GS} = -2.7V, I_D = -1.8A$ ③
$V_{GS(th)}$	Gate Threshold Voltage	-0.70	—	—	V	$V_{DS} = V_{GS}, I_D = -250\mu A$
g_{fs}	Forward Transconductance	4.0	—	—	S	$V_{DS} = -16V, I_D = -2.2A$
I_{DSS}	Drain-to-Source Leakage Current	—	—	-1.0	μA	$V_{DS} = -16V, V_{GS} = 0V$
		—	—	-25		$V_{DS} = -16V, V_{GS} = 0V, T_J = 125^\circ\text{C}$
I_{GSS}	Gate-to-Source Forward Leakage	—	—	-100	nA	$V_{GS} = -12V$
	Gate-to-Source Reverse Leakage	—	—	100		$V_{GS} = 12V$
Q_g	Total Gate Charge	—	—	22	nC	$I_D = -2.2A$
Q_{gs}	Gate-to-Source Charge	—	—	3.3		$V_{DS} = -16V$
Q_{gd}	Gate-to-Drain ("Miller") Charge	—	—	9.0		$V_{GS} = -4.5V$, See Fig. 6 and 12 ③
$t_{d(on)}$	Turn-On Delay Time	—	8.4	—	ns	$V_{DD} = -10V$
t_r	Rise Time	—	26	—		$I_D = -2.2A$
$t_{d(off)}$	Turn-Off Delay Time	—	51	—		$R_G = 6.0\Omega$
t_f	Fall Time	—	33	—		$R_D = 4.5\Omega$, See Fig. 10 ③
L_D	Internal Drain Inductance	—	4.0	—	nH	Between lead tip and center of die contact 
L_S	Internal Source Inductance	—	6.0	—		
C_{iss}	Input Capacitance	—	610	—	pF	$V_{GS} = 0V$
C_{oss}	Output Capacitance	—	310	—		$V_{DS} = -15V$
C_{rss}	Reverse Transfer Capacitance	—	170	—		$f = 1.0\text{MHz}$, See Fig. 5

Source-Drain Ratings and Characteristics

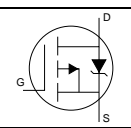
	Parameter	Min.	Typ.	Max.	Units	Conditions
I_S	Continuous Source Current (Body Diode)	—	—	-2.5	A	MOSFET symbol showing the integral reverse p-n junction diode. 
I_{SM}	Pulsed Source Current (Body Diode) ①	—	—	-17		
V_{SD}	Diode Forward Voltage	—	—	-1.0	V	$T_J = 25^\circ\text{C}, I_S = -1.8A, V_{GS} = 0V$ ③
t_{rr}	Reverse Recovery Time	—	56	84	ns	$T_J = 25^\circ\text{C}, I_F = -2.2A$
Q_{rr}	Reverse Recovery Charge	—	71	110	μC	$di/dt = 100A/\mu s$ ③
t_{on}	Forward Turn-On Time	Intrinsic turn-on time is negligible (turn-on is dominated by L_S+L_D)				

Notes:

- ① Repetitive rating; pulse width limited by max. junction temperature. (See fig. 11)
- ② $I_{SD} \leq -2.2A, di/dt \leq -50A/\mu s, V_{DD} \leq V_{(BR)DSS}, T_J \leq 150^\circ\text{C}$
- ③ Pulse width $\leq 300\mu s$; duty cycle $\leq 2\%$.

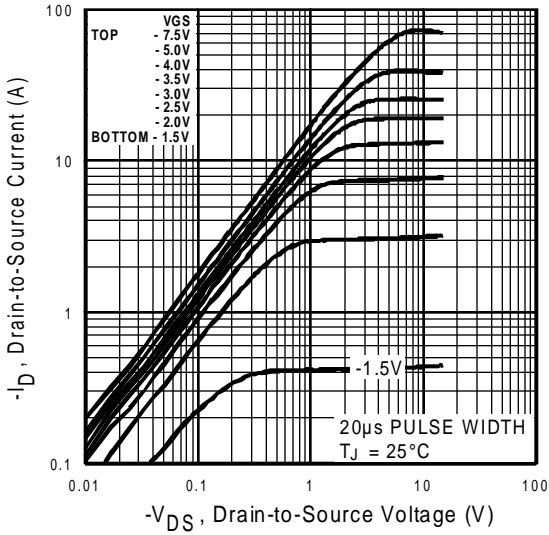

Fig 1. Typical Output Characteristics

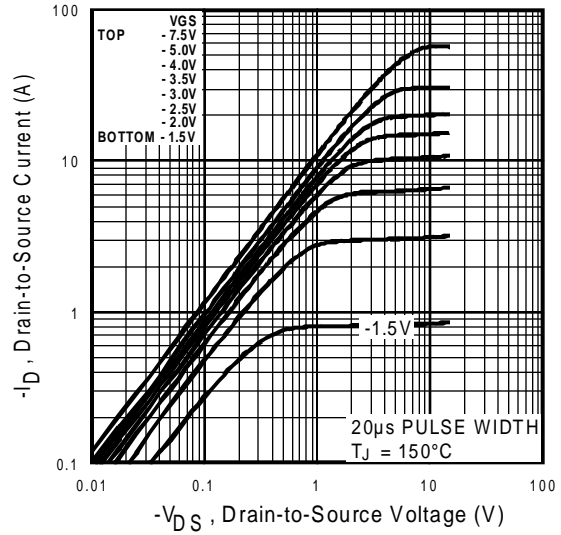

Fig 2. Typical Output Characteristics

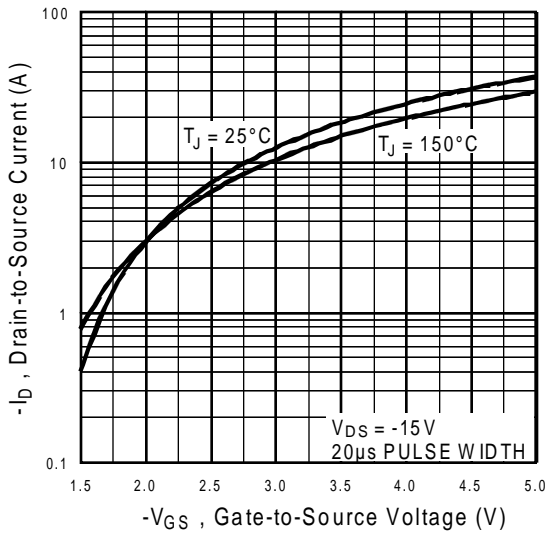

Fig 3. Typical Transfer Characteristics

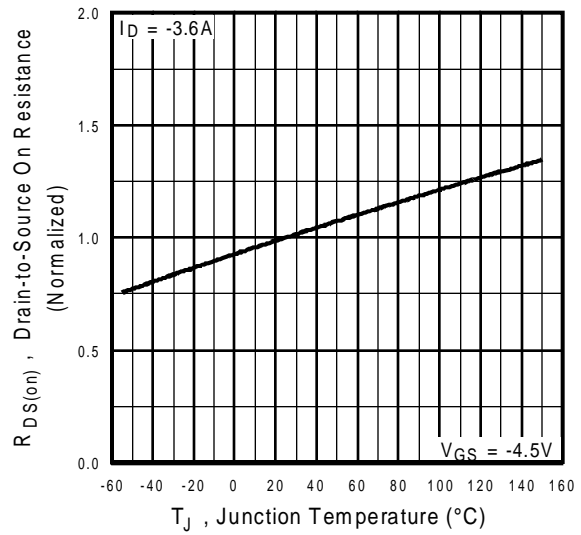

Fig 4. Normalized On-Resistance Vs. Temperature

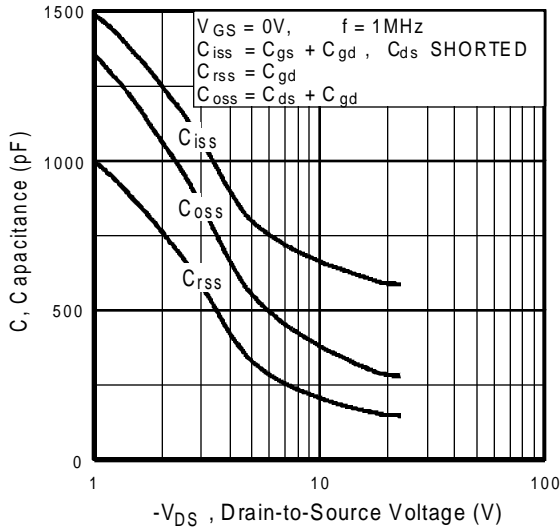

Fig 5. Typical Capacitance Vs. Drain-to-Source Voltage

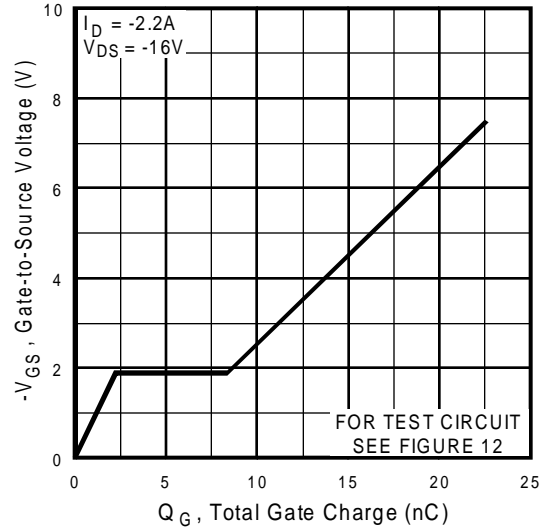

Fig 6. Typical Gate Charge Vs. Gate-to-Source Voltage

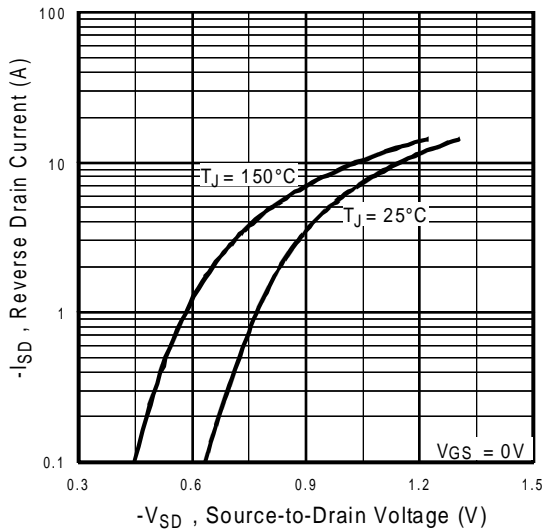

Fig 7. Typical Source-Drain Diode Forward Voltage

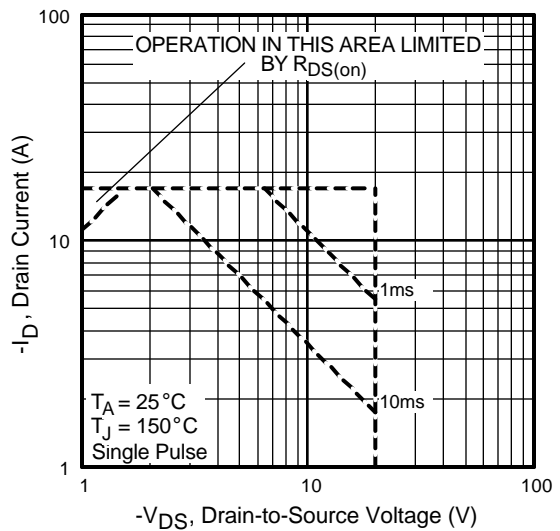

Fig 8. Maximum Safe Operating Area

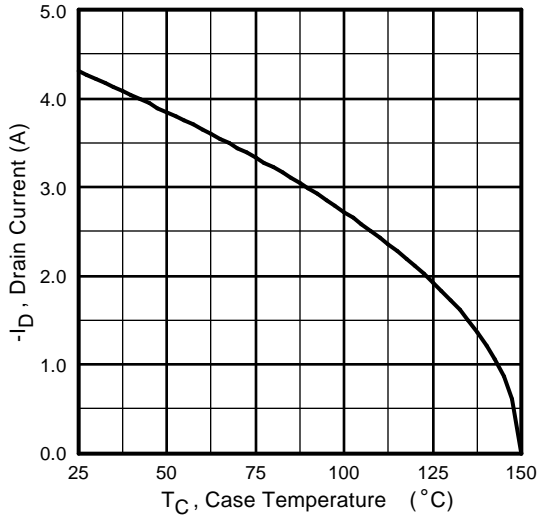

Fig 9. Maximum Drain Current Vs. Ambient Temperature

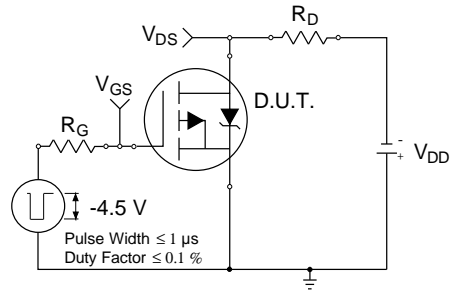

Fig 10a. Switching Time Test Circuit

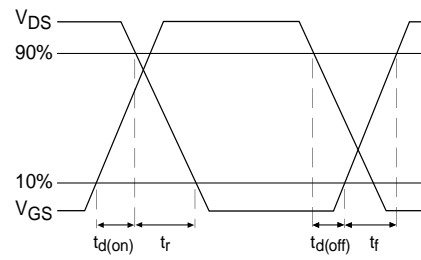

Fig 10b. Switching Time Waveforms

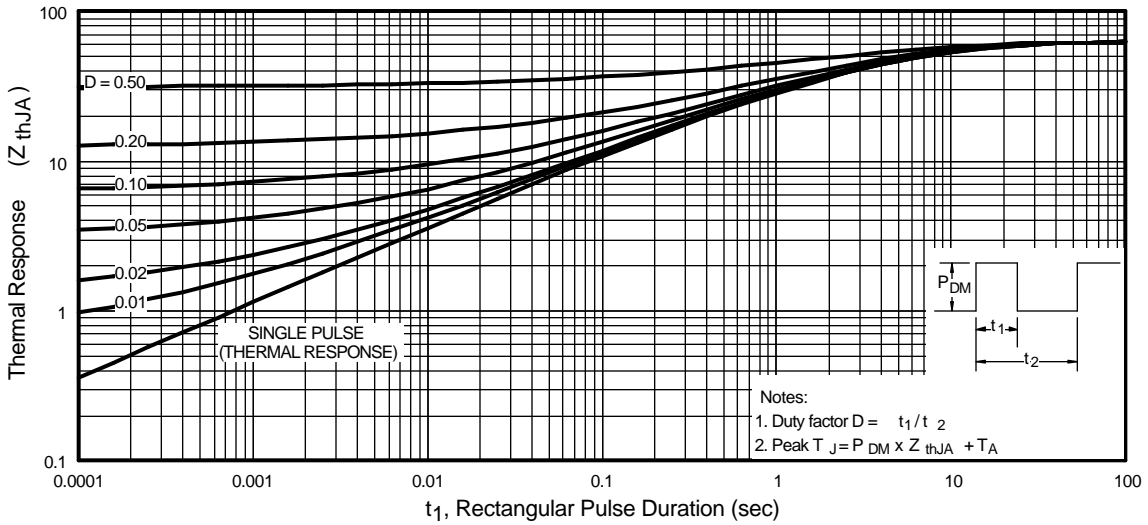

Fig 11. Maximum Effective Transient Thermal Impedance, Junction-to-Ambient

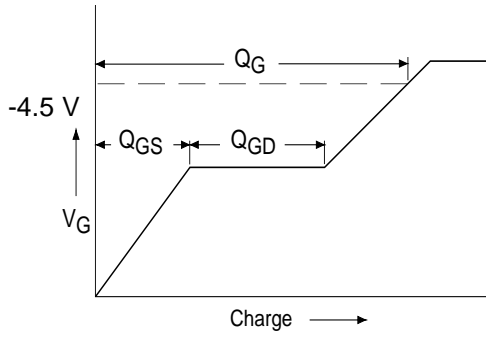

Fig 12a. Basic Gate Charge Waveform

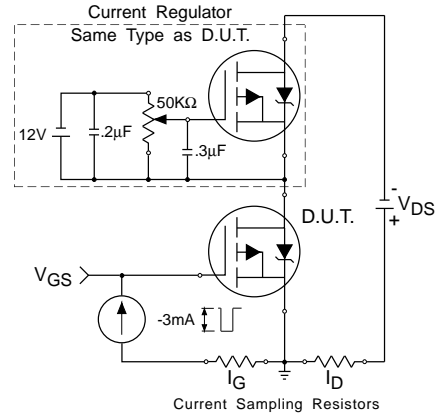
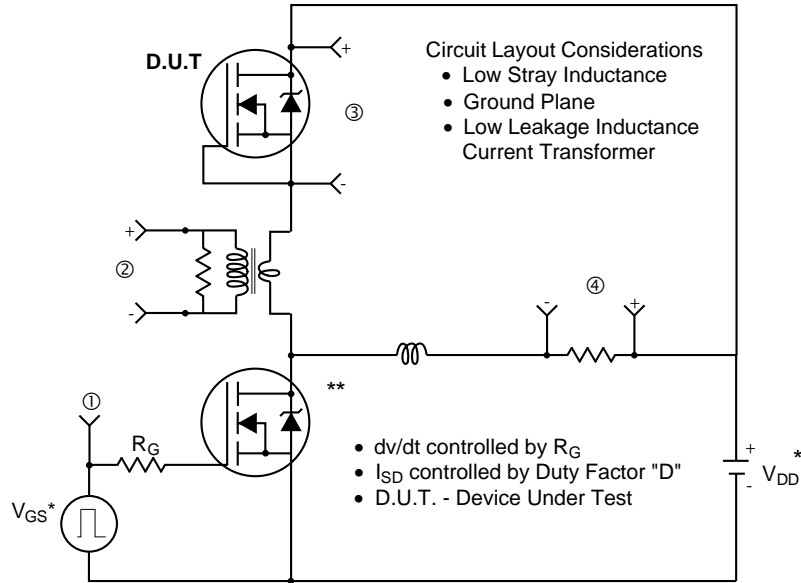

Fig 12b. Gate Charge Test Circuit

Peak Diode Recovery dv/dt Test Circuit



* Reverse Polarity for P-Channel

** Use P-Channel Driver for P-Channel Measurements

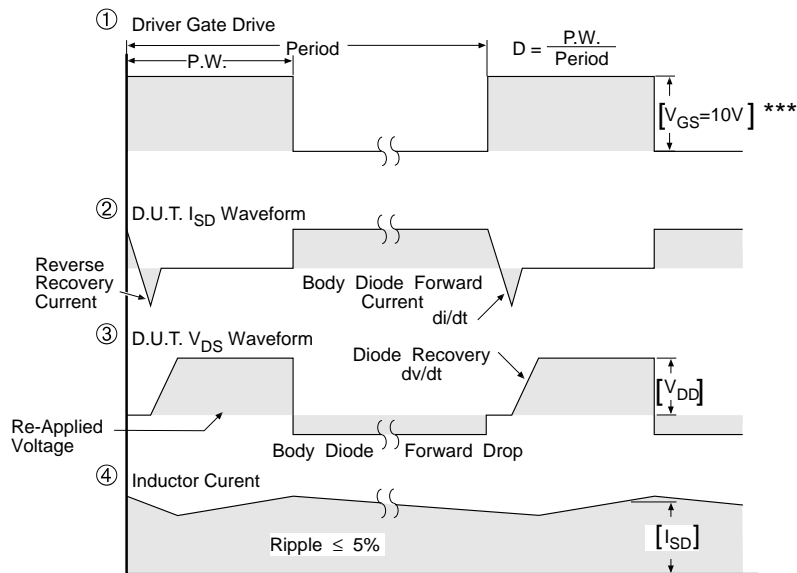

*** $V_{GS} = 5.0V$ for Logic Level and 3V Drive Devices

Fig 13. For P-Channel HEXFETS

IRF7304

Package Outline SO8 Outline

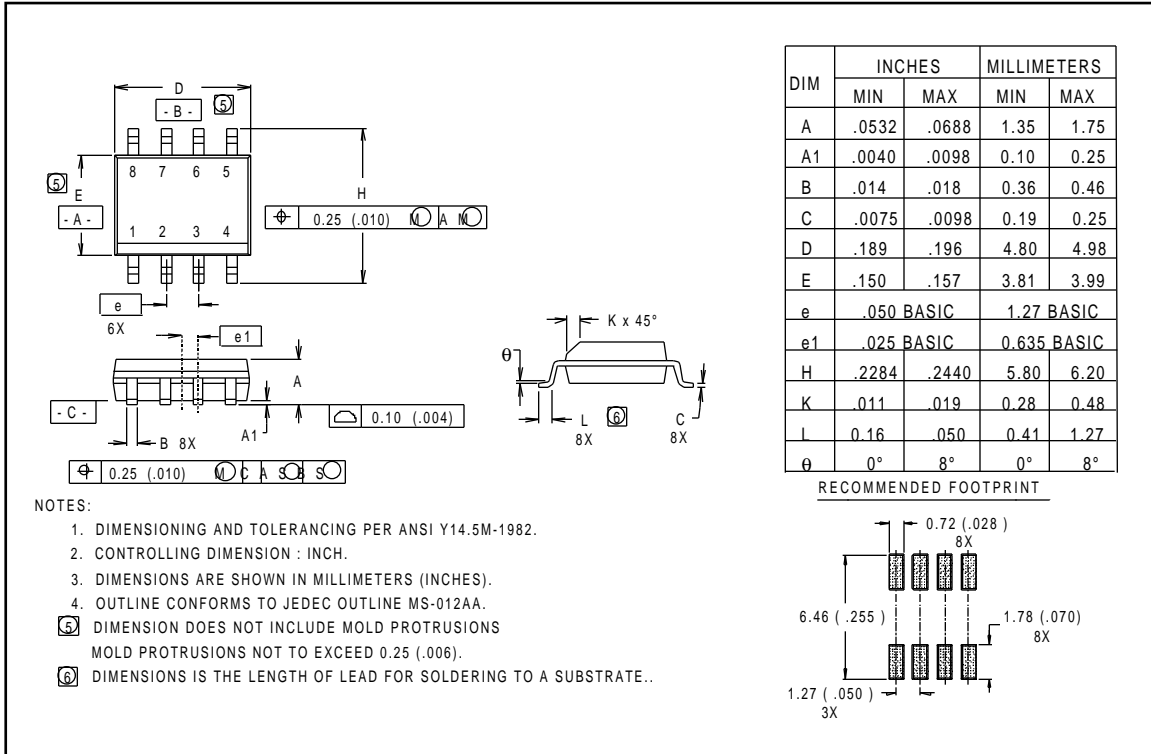

Part Marking Information

SO8

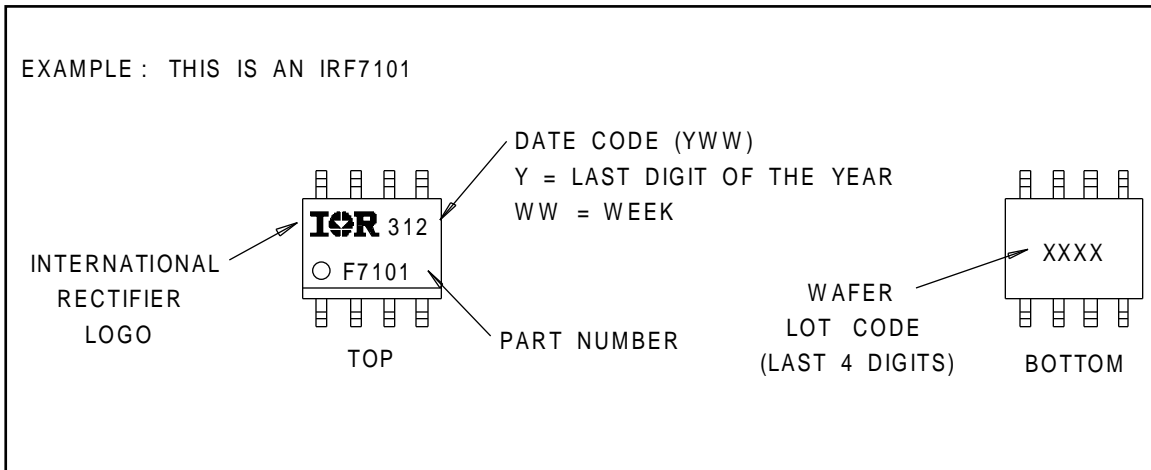

Tape & Reel Information

S08

Dimensions are shown in millimeters (inches)

