



OCTAL D-TYPE FLIP-FLOP WITH 3-STATE OUTPUTS

The MC54/74F534 is a high-speed, low-power octal D-type flip-flop featuring separate D-type inputs for each flip-flop and 3-state outputs for bus oriented applications. A buffered Clock (CP) and Output Enable (OE) are common to all flip-flops. The F534 is the same as the F374 except that the outputs are inverted.

- Edge-Triggered D-Type Inputs
- Buffered Positive Edge-Triggered Clock
- 3-State Outputs for Bus Oriented Applications

CONNECTION DIAGRAM

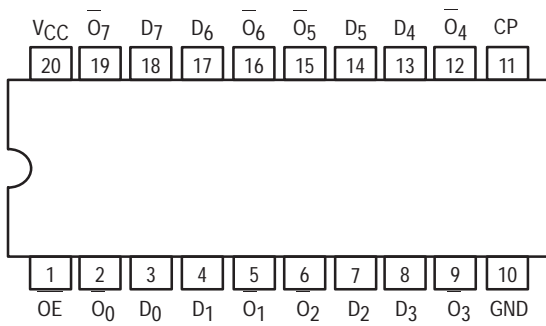

LOGIC SYMBOL

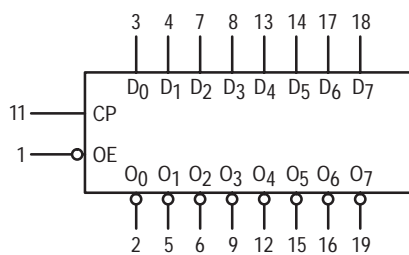

V_{CC} = PIN 20
GND = PIN 10

MC54/74F534

OCTAL D-TYPE FLIP-FLOP WITH 3-STATE OUTPUTS

FAST™ SCHOTTKY TTL

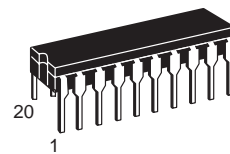

J SUFFIX
CERAMIC
CASE 732-03

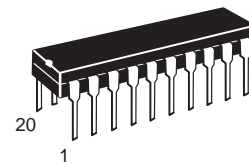

N SUFFIX
PLASTIC
CASE 738-03

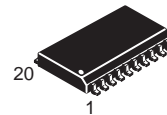

DW SUFFIX
SOIC
CASE 751D-03

ORDERING INFORMATION

MC54FXXXJ Ceramic
MC74FXXXN Plastic
MC74FXXXDW SOIC

GUARANTEED OPERATING RANGES

Symbol	Parameter	Min	Typ	Max	Unit	
V _{CC}	Supply Voltage	54, 74	4.5	5.0	5.5	V
T _A	Operating Ambient Temperature Range	54	-55	25	125	°C
		74	0	25	70	
I _{OH}	Output Current — High	54, 74		-3.0	mA	
I _{OL}	Output Current — Low	54, 74		24	mA	

LIFETIME BUY

LAST SHIP 30/09/99
LAST ORDER 31/03/99

MC54/74F534

LOGIC DIAGRAM

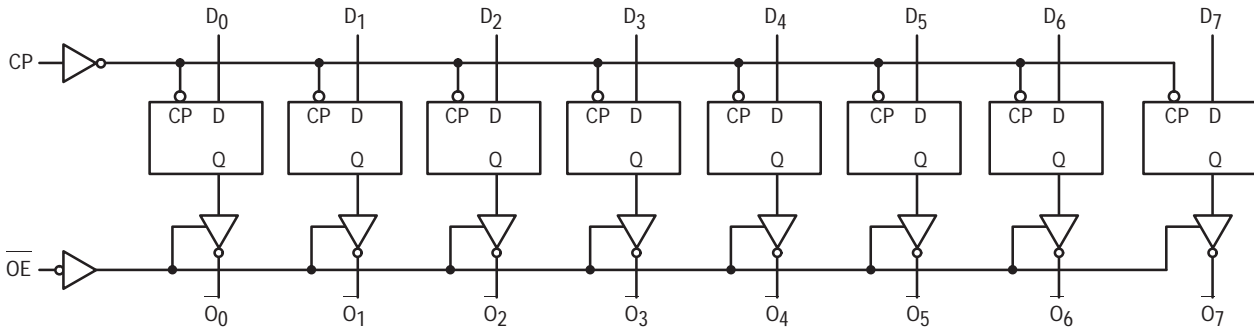

Please note that this diagram is provided only for the understanding of logic operations and should not be used to estimate propagation delays.

FUNCTIONAL DESCRIPTION

The F534 consists of eight edge-triggered flip-flops with individual D-type inputs and 3-state true outputs. The buffered clock and buffered Output Enable are common to all flip-flops. The eight flip-flops will store the state of their individual D inputs that meet the setup and hold times requirements on the

LOW-to-HIGH Clock (CP) transition. With the Output Enable (OE) LOW, the contents of the eight flip-flops are available at the outputs. When the OE is HIGH, the outputs go to the high impedance state. Operation of the OE input does not affect the state of the flip-flops.

DC CHARACTERISTICS OVER OPERATING TEMPERATURE RANGE (unless otherwise specified)

Symbol	Parameter	Limits			Unit	Test Conditions	
		Min	Typ	Max			
V_{IH}	Input HIGH Voltage	2.0			V	Guaranteed Input HIGH Voltage	
V_{IL}	Input LOW Voltage			0.8	V	Guaranteed Input LOW Voltage	
V_{IK}	Input Clamp Diode Voltage			-1.2	V	$I_{IN} = -18 \text{ mA}$	$V_{CC} = \text{MIN}$
V_{OH}	Output HIGH Voltage	54, 74	2.4	3.3	V	$I_{OH} = -3.0 \text{ mA}$	$V_{CC} = 4.5 \text{ V}$
		74	2.7	3.3	V	$I_{OH} = -3.0 \text{ mA}$	$V_{CC} = 4.75 \text{ V}$
V_{OL}	Output LOW Voltage		0.35	0.5	V	$I_{OL} = 24 \text{ mA}$	$V_{CC} = \text{MIN}$
I_{OZH}	Output OFF Current — HIGH			50	μA	$V_{OUT} = 2.7 \text{ V}$	$V_{CC} = \text{MAX}$
I_{OZL}	Output OFF Current — LOW			-50	μA	$V_{OUT} = 0.5 \text{ V}$	$V_{CC} = \text{MAX}$
I_{IH}	Input HIGH Current			20	μA	$V_{IN} = 2.7 \text{ V}$	$V_{CC} = \text{MAX}$
				100		$V_{IN} = 7.0 \text{ V}$	
I_{IL}	Input LOW Current			-0.6	mA	$V_{IN} = 0.5 \text{ V}$	$V_{CC} = \text{MAX}$
I_{OS}	Output Short Circuit Current (Note 2)	-60		-150	mA	$V_{OUT} = 0 \text{ V}$	$V_{CC} = \text{MAX}$
I_{CCZ}	Power Supply Current		55	86	mA	$D_n = \text{Gnd}$ $\text{OE} = 4.5 \text{ V}$	$V_{CC} = \text{MAX}$

NOTES:

1. For conditions such as MIN or MAX, use the appropriate value specified under guaranteed operating ranges.
2. Not more than one output should be shorted at a time, nor for more than 1 second.

LIFETIME BUY

LAST SHIP 30/09/99 LAST ORDER 31/03/99

MC54/74F534

AC CHARACTERISTICS

Symbol	Parameter	54/74F			54F		74F		Unit
		T _A = +25°C V _{CC} = +5.0 V C _L = 50 pF			T _A = -55 to +125°C V _{CC} = 5.0 V ±10% C _L = 50 pF		T _A = 0 to +70°C V _{CC} = 5.0 V ±10% C _L = 50 pF		
		Min	Typ	Max	Min	Max	Min	Max	
f _{max}	Maximum Clock Frequency	100			60		70		MHz
t _{PLH} t _{PHL}	Propagation Delay CP to O _n	4.0	6.5	8.5	4.0	10.5	4.0	10	ns
t _{PZH} t _{PZL}	Output Enable Time	2.0	9.0	11.5	2.0	14	2.0	12.5	ns
t _{PHZ} t _{PLZ}	Output Disable Time	2.0	5.3	7.0	2.0	8.0	2.0	8.0	
		2.0	4.3	5.5	2.0	7.5	2.0	6.5	

AC OPERATING REQUIREMENTS

Symbol	Parameter	54/74F			54F		74F		Unit
		T _A = +25°C V _{CC} = +5.0 V			T _A = -55 to +125°C V _{CC} = 5.0 V ±10%		T _A = 0 to +70°C V _{CC} = 5.0 V ±10%		
		Min	Typ	Max	Min	Max	Min	Max	
t _S (H) t _S (L)	Setup Time, HIGH or LOW D _n to CP	2.0			2.5		2.0		ns
t _H (H) t _H (L)	Hold Time, HIGH or LOW D _n to CP	2.0			2.0		2.0		
t _w (H) t _w (L)	CP Pulse Width HIGH or LOW	7.0			7.0		7.0		ns
		6.0			6.0		6.0		

LIFETIME BUY

LAST SHIP 30/09/99 LAST ORDER 31/03/99

LIFETIME BUY

LAST ORDER 31/03/99 LAST SHIP 30/09/99

Mfax is a trademark of Motorola, Inc.

Motorola reserves the right to make changes without further notice to any products herein. Motorola makes no warranty, representation or guarantee regarding the suitability of its products for any particular purpose, nor does Motorola assume any liability arising out of the application or use of any product or circuit, and specifically disclaims any and all liability, including without limitation consequential or incidental damages. "Typical" parameters which may be provided in Motorola data sheets and/or specifications can and do vary in different applications and actual performance may vary over time. All operating parameters, including "Typicals" must be validated for each customer application by customer's technical experts. Motorola does not convey any license under its patent rights nor the rights of others. Motorola products are not designed, intended, or authorized for use as components in systems intended for surgical implant into the body, or other applications intended to support or sustain life, or for any other application in which the failure of the Motorola product could create a situation where personal injury or death may occur. Should Buyer purchase or use Motorola products for any such unintended or unauthorized application, Buyer shall indemnify and hold Motorola and its officers, employees, subsidiaries, affiliates, and distributors harmless against all claims, costs, damages, and expenses, and reasonable attorney fees arising out of, directly or indirectly, any claim of personal injury or death associated with such unintended or unauthorized use, even if such claim alleges that Motorola was negligent regarding the design or manufacture of the part. Motorola and  are registered trademarks of Motorola, Inc. Motorola, Inc. is an Equal Opportunity/Affirmative Action Employer.

How to reach us:

USA/EUROPE/Locations Not Listed: Motorola Literature Distribution; P.O. Box 5405, Denver, Colorado 80217.
1-303-675-2140 or 1-800-441-2447

JAPAN: Motorola Japan Ltd.; SPS, Technical Information Center, 3-20-1, Minami-Azabu. Minato-ku, Tokyo 106-8573 Japan.
81-3-3440-3569

ASIA/PACIFIC: Motorola Semiconductors H.K. Ltd.; Silicon Harbour Centre, 2 Dai King Street, Tai Po Industrial Estate, Tai Po, N.T., Hong Kong. 852-26668334

Customer Focus Center: 1-800-521-6274

Mfax™: RMFAX0@email.sps.mot.com – TOUCHTONE 1-602-244-6609
Motorola Fax Back System – US & Canada ONLY 1-800-774-1848
– <http://sps.motorola.com/mfax/>

HOME PAGE: <http://motorola.com/sps/>



MOTOROLA

