

HD74HC4020

14-stage Binary Counter

HITACHI

ADE-205-531 (Z)
1st. Edition
Sep. 2000



Description

The HD74HC4020 is a 14 stage counter. This device is incremented on the falling edge (negative transition) of the input clock, and all its output is reset to a low level by applying a logical high on its reset input.

Features

- High Speed Operation: t_{pd} (Clock to Q_1) = 14 ns typ ($C_L = 50$ pF)
- High Output Current: Fanout of 10 LSTTL Loads
- Wide Operating Voltage: $V_{CC} = 2$ to 6 V
- Low Input Current: 1 μ A max
- Low Quiescent Supply Current: I_{CC} (static) = 4 μ A max ($T_a = 25^\circ\text{C}$)

Function Table

Clock	Reset	Outputs State
	L	No change
	L	Advance to next state
X	H	All output are low

HD74HC4020

Pin Arrangement

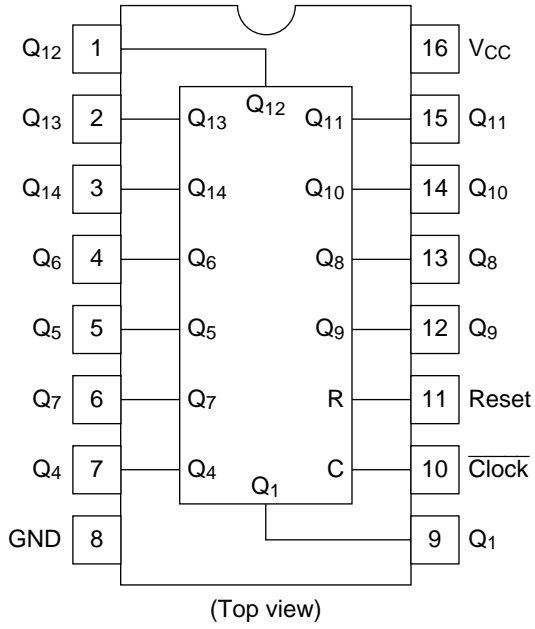

Block Diagram

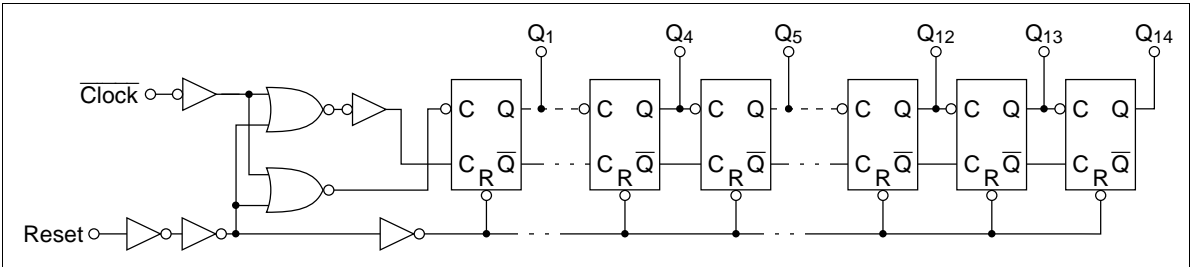

HITACHI

Timing Diagram

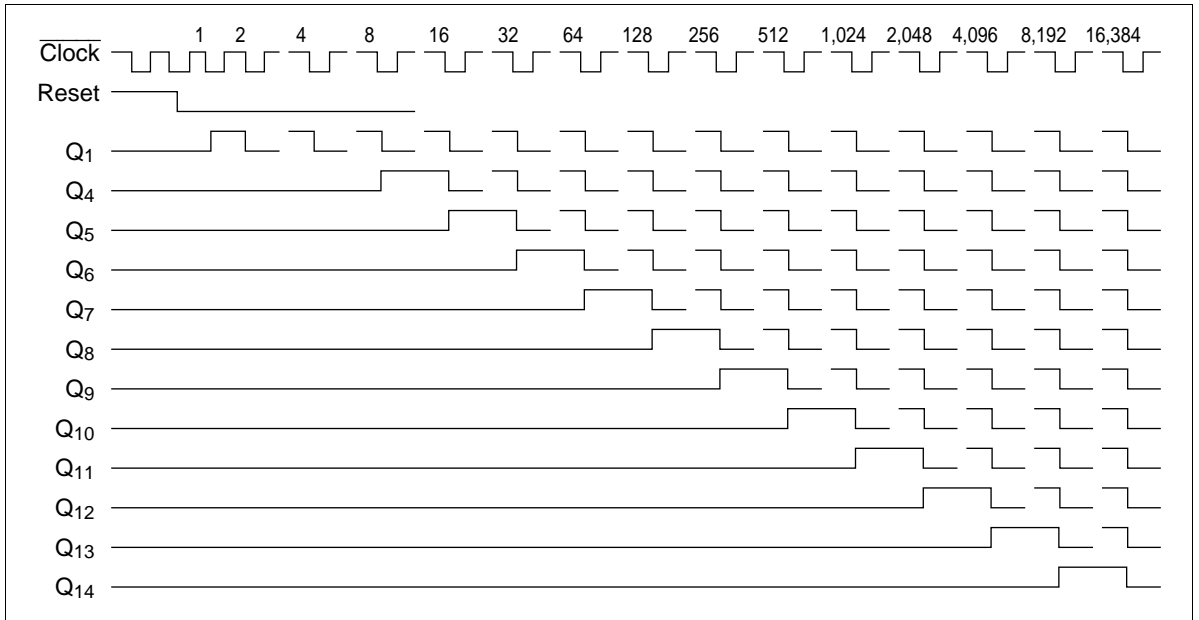

DC Characteristics

Item	Symbol	V _{CC} (V)	Ta = 25°C			Ta = -40 to +85°C		Unit	Test Conditions	
			Min	Typ	Max	Min	Max			
Input voltage	V _{IH}	2.0	1.5	—	—	1.5	—	V		
		4.5	3.15	—	—	3.15	—			
		6.0	4.2	—	—	4.2	—			
	V _{IL}	2.0	—	—	0.5	—	0.5			V
		4.5	—	—	1.35	—	1.35			
		6.0	—	—	1.8	—	1.8			
Output voltage	V _{OH}	2.0	1.9	2.0	—	1.9	—	V	Vin = V _{IH} or V _{IL} I _{OH} = -20 μA	
		4.5	4.4	4.5	—	4.4	—			
		6.0	5.9	6.0	—	5.9	—			
		4.5	4.18	—	—	4.13	—			I _{OH} = -4 mA
		6.0	5.68	—	—	5.63	—			I _{OH} = -5.2 mA
	V _{OL}	2.0	—	0.0	0.1	—	0.1	V	Vin = V _{IH} or V _{IL} I _{OL} = 20 μA	
		4.5	—	0.0	0.1	—	0.1			
		6.0	—	0.0	0.1	—	0.1			
		4.5	—	—	0.26	—	0.33			I _{OL} = 4 mA
		6.0	—	—	0.26	—	0.33			I _{OL} = 5.2 mA
Input current	I _{in}	6.0	—	—	±0.1	—	±1.0	μA	Vin = V _{CC} or GND	
Quiescent supply current	I _{CC}	6.0	—	—	4.0	—	40	μA	Vin = V _{CC} or GND, I _{out} = 0 μA	

AC Characteristics ($C_L = 50$ pF, Input $t_r = t_f = 6$ ns)

Item	Symbol	V_{CC} (V)	$T_a = 25^\circ\text{C}$			$T_a = -40$ to $+85^\circ\text{C}$		Unit	Test Conditions
			Min	Typ	Max	Min	Max		
Maximum clock frequency	f_{max}	2.0	—	—	5	—	4	MHz	
		4.5	—	—	25	—	20		
		6.0	—	—	29	—	24		
Propagation delay time	t_{PLH}	2.0	—	—	175	—	220	ns	Clock to Q_1
		4.5	—	14	35	—	44		
		6.0	—	—	30	—	37		
	t_{PHL}	2.0	—	—	175	—	220	ns	Clock to Q_1
		4.5	—	14	35	—	44		
		6.0	—	—	30	—	37		
	t_{PLH}	2.0	—	—	200	—	250	ns	Reset to output
		4.5	—	18	40	—	50		
		6.0	—	—	34	—	43		
	t_{PHL}	2.0	—	—	100	—	125	ns	Q_n to Q_{n-1}
		4.5	—	—	20	—	25		
		6.0	—	—	17	—	21		
Removal time	t_{rem}	2.0	100	—	—	125	—	ns	
		4.5	20	6	—	25	—		
		6.0	17	—	—	21	—		
Pulse width	t_w	2.0	80	—	—	100	—	ns	
		4.5	16	4	—	20	—		
		6.0	14	—	—	17	—		
Output rise/fall time	t_{TLH}	2.0	—	—	75	—	95	ns	
		4.5	—	5	15	—	19		
		6.0	—	—	13	—	16		
Input capacitance	C_{in}	—	—	5	10	—	10	pF	

Package Dimensions

Unit: mm

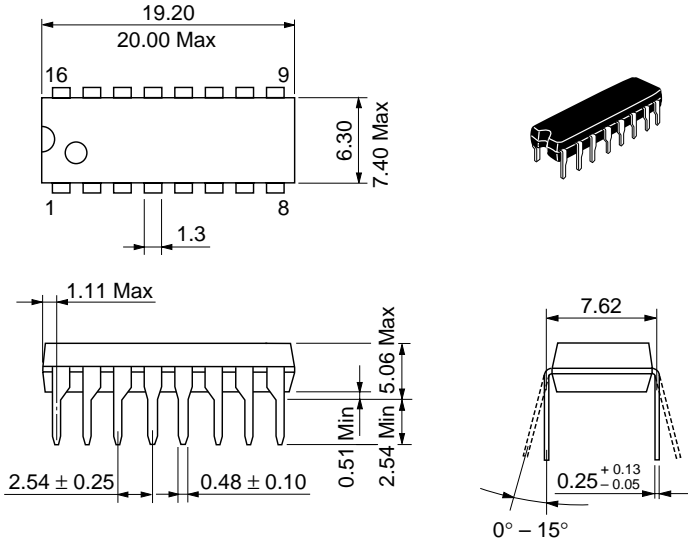

Hitachi Code	DP-16
JEDEC	Conforms
EIAJ	Conforms
Mass (reference value)	1.07 g

Unit: mm

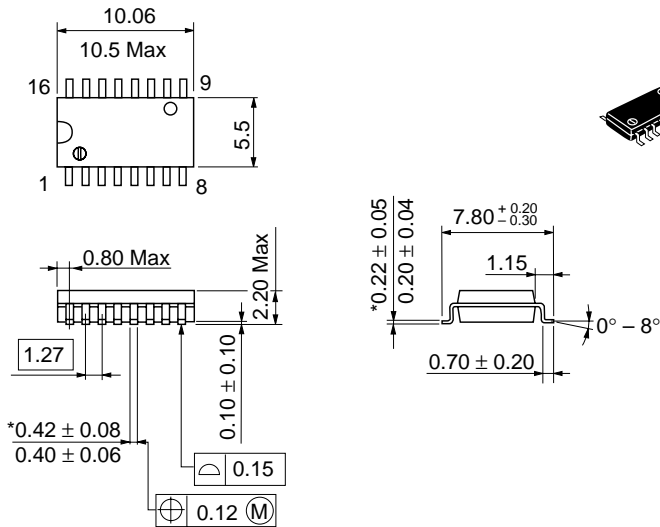

*Dimension including the plating thickness
Base material dimension

Hitachi Code	FP-16DA
JEDEC	—
EIAJ	Conforms
Mass (reference value)	0.24 g

Cautions

1. Hitachi neither warrants nor grants licenses of any rights of Hitachi's or any third party's patent, copyright, trademark, or other intellectual property rights for information contained in this document. Hitachi bears no responsibility for problems that may arise with third party's rights, including intellectual property rights, in connection with use of the information contained in this document.
2. Products and product specifications may be subject to change without notice. Confirm that you have received the latest product standards or specifications before final design, purchase or use.
3. Hitachi makes every attempt to ensure that its products are of high quality and reliability. However, contact Hitachi's sales office before using the product in an application that demands especially high quality and reliability or where its failure or malfunction may directly threaten human life or cause risk of bodily injury, such as aerospace, aeronautics, nuclear power, combustion control, transportation, traffic, safety equipment or medical equipment for life support.
4. Design your application so that the product is used within the ranges guaranteed by Hitachi particularly for maximum rating, operating supply voltage range, heat radiation characteristics, installation conditions and other characteristics. Hitachi bears no responsibility for failure or damage when used beyond the guaranteed ranges. Even within the guaranteed ranges, consider normally foreseeable failure rates or failure modes in semiconductor devices and employ systemic measures such as fail-safes, so that the equipment incorporating Hitachi product does not cause bodily injury, fire or other consequential damage due to operation of the Hitachi product.
5. This product is not designed to be radiation resistant.
6. No one is permitted to reproduce or duplicate, in any form, the whole or part of this document without written approval from Hitachi.
7. Contact Hitachi's sales office for any questions regarding this document or Hitachi semiconductor products.

HITACHI

Hitachi, Ltd.

Semiconductor & Integrated Circuits.
Nippon Bldg., 2-6-2, Ohte-machi, Chiyoda-ku, Tokyo 100-0004, Japan
Tel: Tokyo (03) 3270-2111 Fax: (03) 3270-5109

URL	North America	: http://semiconductor.hitachi.com/
	Europe	: http://www.hitachi-eu.com/hel/ecg
	Asia	: http://sicapac.hitachi-asia.com
	Japan	: http://www.hitachi.co.jp/Sicd/indx.htm

For further information write to:

Hitachi Semiconductor
(America) Inc.
179 East Tasman Drive,
San Jose, CA 95134
Tel: <1> (408) 433-1990
Fax: <1> (408) 433-0223

Hitachi Europe GmbH
Electronic Components Group
Dornacher Straße 3
D-85622 Feldkirchen, Munich
Germany
Tel: <49> (89) 9 9180-0
Fax: <49> (89) 9 29 30 00

Hitachi Europe Ltd.
Electronic Components Group.
Whitebrook Park
Lower Cookham Road
Maidenhead
Berkshire SL6 8YA, United Kingdom
Tel: <44> (1628) 585000
Fax: <44> (1628) 585160

Hitachi Asia Ltd.
Hitachi Tower
16 Collyer Quay #20-00,
Singapore 049318
Tel: <65>-538-6533/538-8577
Fax : <65>-538-6933/538-3877
URL : <http://www.hitachi.com.sg>

Hitachi Asia Ltd.
(Taipei Branch Office)
4/F, No. 167, Tun Hwa North Road,
Hung-Kuo Building,
Taipei (105), Taiwan
Tel: <886>-(2)-2718-3666
Fax : <886>-(2)-2718-8180
Telex : 23222 HAS-TP
URL : <http://www.hitachi.com.tw>

Hitachi Asia (Hong Kong) Ltd.
Group III (Electronic Components)
7/F., North Tower,
World Finance Centre,
Harbour City, Canton Road
Tsim Sha Tsui, Kowloon,
Hong Kong
Tel : <852>-(2)-735-9218
Fax : <852>-(2)-730-0281
URL : <http://www.hitachi.com.hk>

Copyright © Hitachi, Ltd., 2000. All rights reserved. Printed in Japan.
Colophon 2.0

HITACHI