

Am29C827/Am29C828 Am29C927/Am29C928

High-Performance CMOS Bus Buffers

Am29C827/Am29C828
Am29C927/Am29C928

DISTINCTIVE CHARACTERISTICS

- High-speed CMOS buffers and inverters
 - D-Y delay = 7 ns typical
- Low standby power
- JEDEC FCT-compatible specs
- $I_{OL} = 24$ mA, Commercial and Military
- 200-mV typical hysteresis on data input ports
- Am29C900 DIP pinout option reduces lead inductance on V_{CC} and GND pins

GENERAL DESCRIPTION

The Am29C827 and Am29C828 CMOS Bus Buffers provide high-performance bus interface buffering for wide address/data paths or buses carrying parity. Both devices feature 10-bit wide data paths and NORed output enables for maximum control flexibility. The Am29C827 has non-inverting outputs, while the Am29C828 has inverting outputs. Each device has data inputs with 200-mV typical input hysteresis to provide improved noise immunity. The Am29C827 and Am29C828 are produced with AMD's exclusive CS-11 CMOS process, and feature typical propa-

gation delays of 7 ns, as well as an output current drive of 24 mA.

The Am29C827 and Am29C828 are available in the standard package options: DIPs, PLCCs, LCCs, SOICs, and Flatpacks. In addition, a DIP pinout option, featuring center V_{CC} and GND pins, reduces the lead inductance of the V_{CC} and GND pins. The ordering part numbers for CMOS buffers with this pinout are the Am29C927 and Am29C928; their pinouts are shown later in this data sheet.

BLOCK DIAGRAMS

Am29C827 (Noninverting)

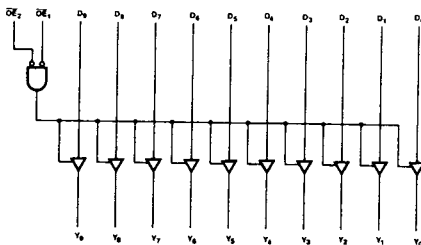

BD001092

Am29C828 (Inverting)

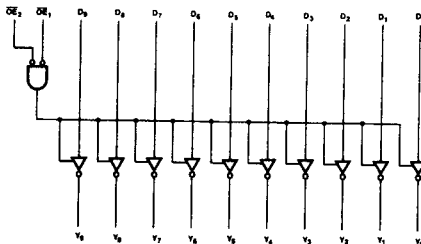

BD001093

Publication # Rev. Amendment
05308 C /0
Issue Date: January 1988

CONNECTION DIAGRAMS Top View

 Am29C827/Am29C828
 Am29C927/Am29C928

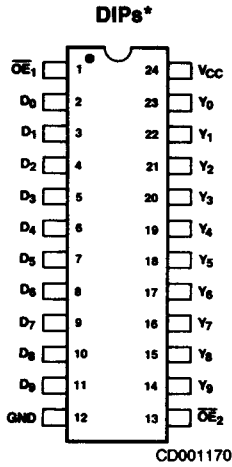
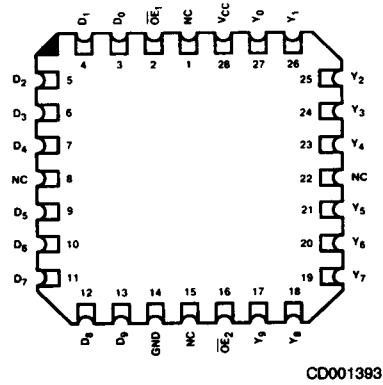
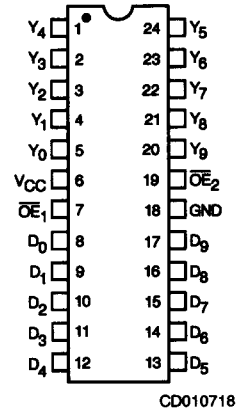
Am29C827/Am29C828

LCC**

**Am29C927/
Am29C928**
DIPs

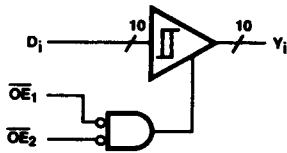
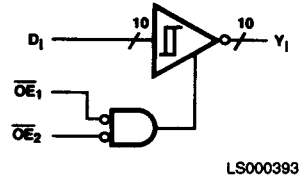
*Also available in 24-Pin Flatpack and Small Outline packages; pinout identical to DIPs.
 **Also available in 28-Pin PLCC; pinout identical to LCC.

LOGIC SYMBOLS

Am29C827

Am29C828

FUNCTION TABLES

Am29C827

Inputs			Outputs	Function
OE ₁	OE ₂	D ₁	Y ₁	
L	L	H	H	Transparent
L	L	L	L	Transparent
X	H	X	Z	Hi-Z
H	X	X	Z	Hi-Z

Am29C828

Inputs			Outputs	Function
OE ₁	OE ₂	D ₁	Y ₁	
L	L	H	L	Transparent
L	L	L	H	Transparent
X	H	X	Z	Hi-Z
H	X	X	Z	Hi-Z

H = HIGH
 L = LOW
 X = Don't Care
 Z = Hi-Z

ORDERING INFORMATION Standard Products

AMD products are available in several packages and operating ranges. The order number (Valid Combination) is formed by a combination of:

- a. **Device Number**
- b. **Speed Option** (if applicable)
- c. **Package Type**
- d. **Temperature Range**
- e. **Optional Processing**

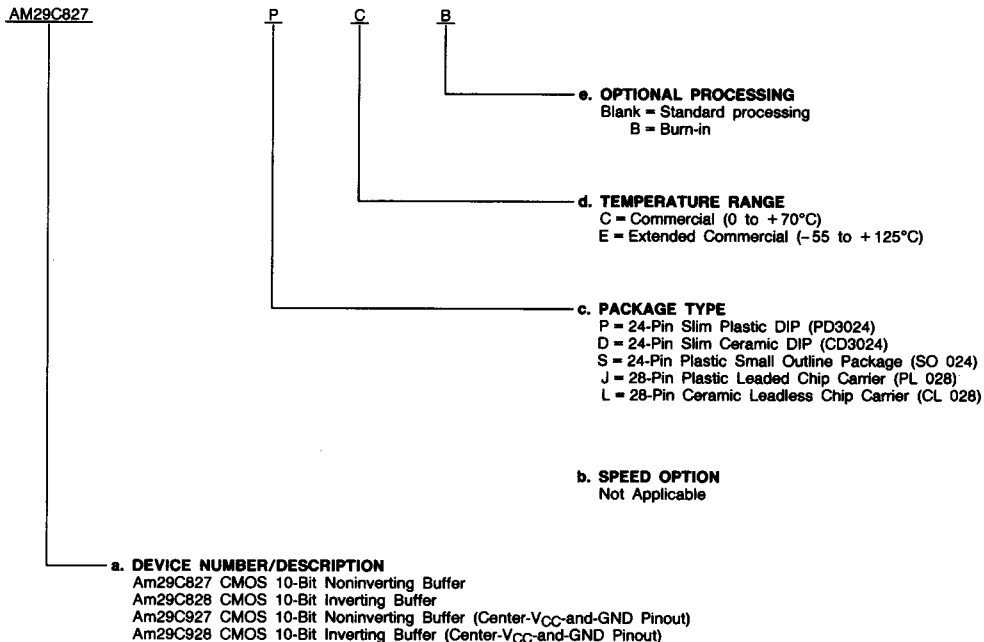

Valid Combinations	
AM29C827	PC, PCB, DC, DCB,
AM29C828	DE, SC, JC, LC
AM29C927	PC, PCB, DC, DCB,
AM29C928	DE

Valid Combinations

Valid Combinations list configurations planned to be supported in volume for this device. Consult the local AMD sales office to confirm availability of specific valid combinations, to check on newly released valid combinations, and to obtain additional data on AMD's standard military grade products.

ORDERING INFORMATION (Cont'd.)

APL Products

AMD products for Aerospace and Defense applications are available in several packages and operating ranges. APL (Approved Products List) products are fully compliant with MIL-STD-883C requirements. The order number (Valid Combination) for APL products is formed by a combination of:

- a. **Device Number**
- b. **Speed Option** (if applicable)
- c. **Device Class**
- d. **Package Type**
- e. **Lead Finish**

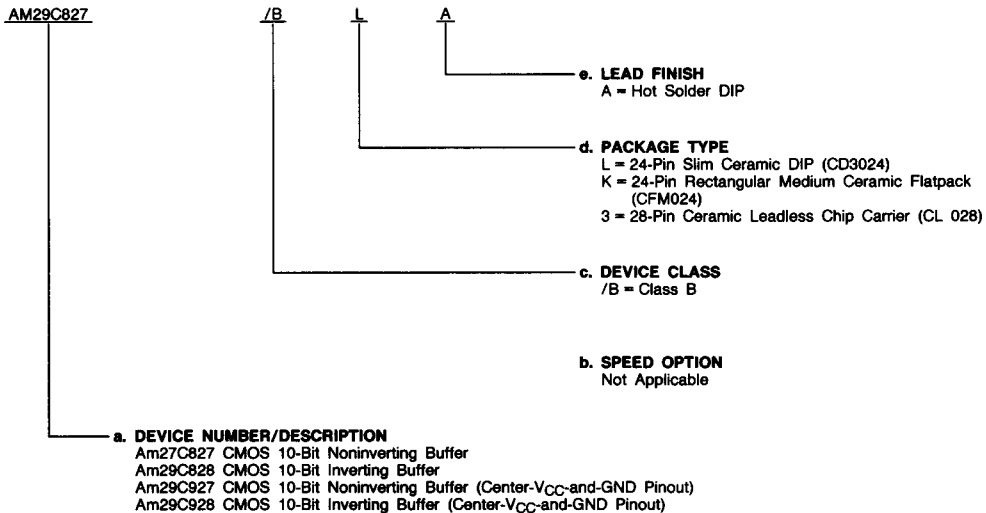

Valid Combinations	
AM29C827	/BLA, /BKA, /B3A
AM29C828	
AM29C927	/BLA
AM29C928	

Valid Combinations

Valid Combinations list configurations planned to be supported in volume for this device. Consult the local AMD sales office to confirm availability of specific valid combinations or to check for newly released valid combinations.

Group A Tests

Group A tests consist of Subgroups 1, 2, 3, 7, 8, 9, 10, 11.

PIN DESCRIPTION

\overline{OE}_1 Output Enables (Input, Active LOW)

When \overline{OE}_1 and \overline{OE}_2 are both LOW, the outputs are enabled. When either one or both are HIGH, the outputs are in the Hi-Z state.

D_i Data Inputs (Input)

D_i are the 10-bit data inputs.

Y_i Data Output (Output)

Y_i are the 10-bit data outputs.

ABSOLUTE MAXIMUM RATINGS

Storage Temperature	-65 to +150°C
Supply Voltage to Ground Potential	
Continuous	-0.5 V to +7.0 V
DC Output Voltage	-0.5 V to $V_{CC} + 0.5$ V
DC Input Voltage	-0.5 V to $V_{CC} + 0.5$ V
DC Output Diode Current: Into Output	+50 mA
Out of Output	-50 mA
DC Input Diode Current: Into Input	+20 mA
Out of Input	-20 mA
DC Output Current per Pin:	
I_{SINK}	+48 mA ($2 \times I_{OL}$)
I_{SOURCE}	-30 mA ($2 \times I_{OH}$)
Total DC Ground Current ($n \times I_{OL} + m \times I_{CCT}$) mA (Note 1)	
Total DC V_{CC} Current ($n \times I_{OH} + m \times I_{CCT}$) mA (Note 1)	

Stresses above those listed under ABSOLUTE MAXIMUM RATINGS may cause permanent device failure. Functionality at or above these limits is not implied. Exposure to absolute maximum ratings for extended periods may affect device reliability.

OPERATING RANGES

Commercial (C) Devices	
Temperature (T_A)	0 to +70°C
Supply Voltage (V_{CC})	+4.5 V to +5.5 V
Military (M) and Extended Commercial (E) Devices	
Temperature (T_A)	-55 to +125°C
Supply Voltage (V_{CC})	+4.5 V to +5.5 V

Operating ranges define those limits between which the functionality of the device is guaranteed.

DC CHARACTERISTICS over operating range unless otherwise specified (for APL Products, Group A, Subgroups 1, 2, 3 are tested unless otherwise noted)

Parameter Symbol	Parameter Description	Test Conditions		Min.	Max.	Units
V_{OH}	Output HIGH Voltage	$V_{CC} = 4.5$ V $V_{IN} = V_{IH}$ or V_{IL}	$I_{OH} = -15$ mA	2.4		Volts
V_{OL}	Output LOW Voltage	$V_{CC} = 4.5$ V $V_{IN} = V_{IH}$ or V_{IL}	$I_{OL} = 24$ mA		0.5	Volts
V_{IH}	Input HIGH Voltage	Guaranteed Input Logical HIGH Voltage for All Inputs (Note 2)		2.0		Volts
V_{IL}	Input LOW Voltage	Guaranteed Input Logical LOW Voltage for All Inputs (Note 2)			0.8	Volts
V_I	Input Clamp Voltage	$V_{CC} = 4.5$ V, $I_{IN} = -18$ mA			-1.2	Volts
I_{IL}	Input LOW Current	$V_{CC} = 5.5$ V, $V_{IN} = GND$			-10	μ A
		$V_{CC} = 5.5$ V, $V_{IN} = 0.4$ V			-5	
I_{IH}	Input HIGH Current	$V_{CC} = 5.5$ V, $V_{IN} = 2.7$ V			5	μ A
		$V_{CC} = 5.5$ V, $V_{IN} = 5.5$ V			10	
I_{OZH}	Output Off-State Current (High Impedance)	$V_{CC} = 5.5$ V, $V_O = 5.5$ V or 2.7 V (Note 3)			+10	μ A
I_{OZL}		$V_{CC} = 5.5$ V, $V_O = 0.4$ V or GND (Note 3)			-10	μ A
I_{SC}	Output Short-Circuit Current	$V_{CC} = 5.5$ V, $V_O = 0$ V (Note 4)		-60		mA
I_{CCO}	Static Supply Current	$V_{CC} = 5.5$ V Outputs Open	$V_{IN} = V_{CC}$ or GND	MIL	160	μ A
				COM'L	120	
I_{CCT}			$V_{IN} = 3.4$ V	Data Input	1.5	mA/Bit
				$\overline{OE}_1, \overline{OE}_2$	3.0	
I_{CCD}^\dagger	Dynamic Supply Current	$V_{CC} = 5.5$ V (Note 5)		275		μ A/MHz/ Bit

- Notes:**
- n = number of outputs, m = number of inputs.
 - Input thresholds are tested in combination with other DC parameters or by correlation.
 - Off-state currents are only tested at worst-case conditions of $V_{OUT} = 5.5$ V or 0.0 V.
 - Not more than one output should be shorted at a time. Duration should not exceed 100 milliseconds.
 - Measured at a frequency ≤ 10 MHz with 50% duty cycle.

† Not included in Group A tests.

SWITCHING CHARACTERISTICS over operating range unless otherwise specified (for APL Products, Group A, Subgroups 9, 10, 11 are tested unless otherwise noted)

Parameter Symbol	Parameter Description	Test Conditions*	COMMERCIAL		MILITARY		Units
			Min.	Max.	Min.	Max.	
t _{PLH}	Data (D _i) to Output (Y _i) Am29C827 (Noninverting)	C _L = 50 pF R ₁ = 500 Ω R ₂ = 500 Ω		10		12	ns
t _{PHL}				10		12	ns
t _{PLH}	Data (D _i) to Output (Y _i) Am29C828 (Inverting)			10		12	ns
t _{PHL}				10		12	ns
t _{ZH}	Output Enable Time \overline{OE} to Y _i			13		15	ns
t _{ZL}				13		15	ns
t _{HZ}	Output Disable Time \overline{OE} to Y _i			13		15	ns
t _{LZ}				13		15	ns

*See Test Circuit and Waveforms.

PACKAGE OUTLINES*

T-90-20

PD3024

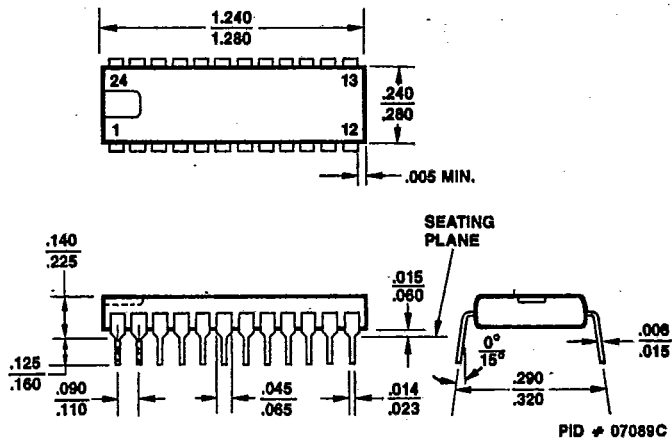

CD3024

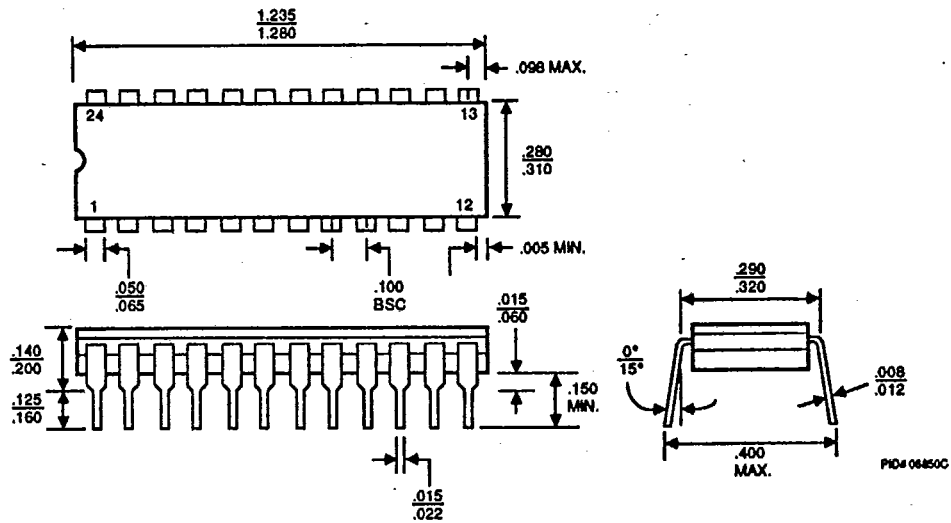

*For reference only.

PACKAGE OUTLINES (Cont'd.)

T-90-20

SO 024

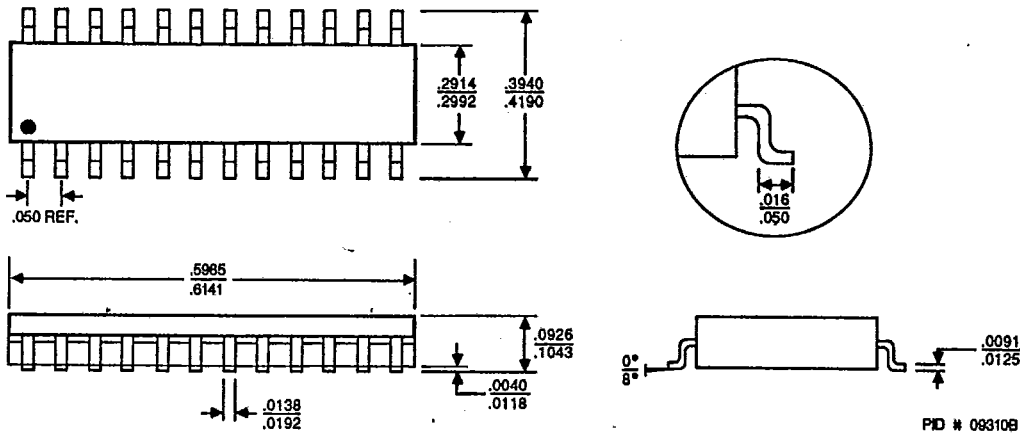

CFM024

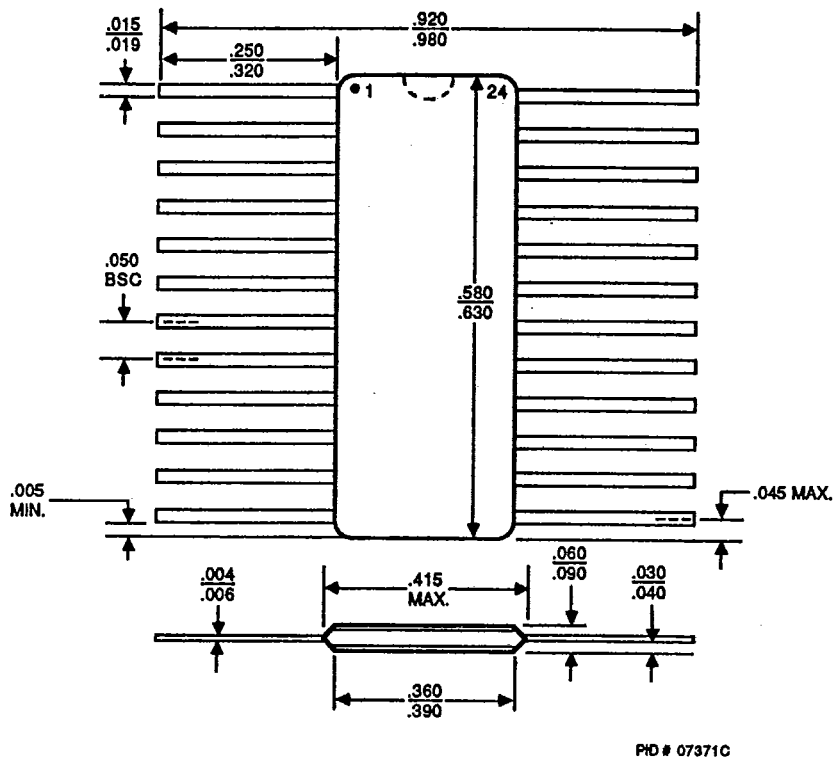

PACKAGE OUTLINES (Cont'd.)

T-90-20

PL 028

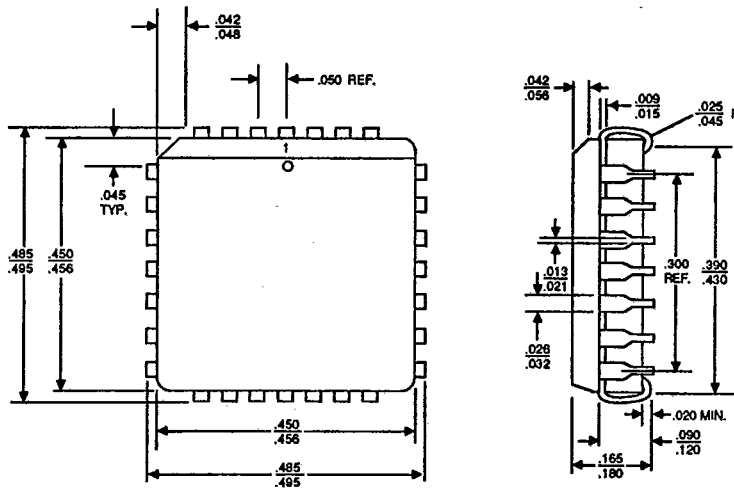

PID # 06751E

CL 028

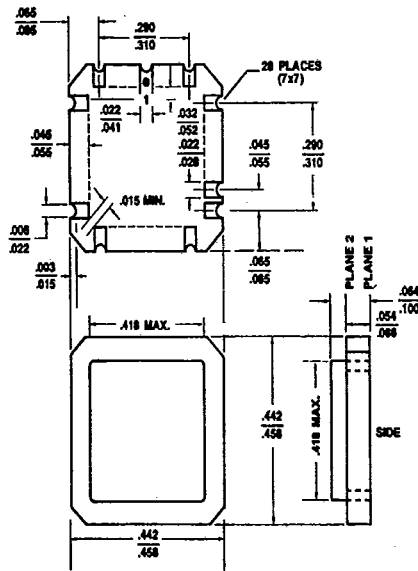

PID # 06595D

Advanced Micro Devices reserves the right to make changes in its product without notice in order to improve design or performance characteristics. The performance characteristics listed in this document are guaranteed by specific tests, correlated testing, guard banding, design and other practices common to the industry. For specific testing details, contact your local AMD sales representative. The company assumes no responsibility for the use of any circuits described herein.



ADVANCED MICRO DEVICES 901 Thompson Pl., P.O. Box 3453, Sunnyvale, CA 94088, USA
 TEL: (408) 732-2400 • TWX: 910-339-9280 • TELEX: 34-6306 • TOLL FREE: (800) 638-8450

© 1988 Advanced Micro Devices, Inc.
 Printed in U.S.A. AIS-WCP-20M-01/88-0