

Am29C821/Am29C823 Am29C921/Am29C923

High-Performance CMOS Bus Interface Registers

Am29C821/Am29C823
Am29C921/Am29C923

DISTINCTIVE CHARACTERISTICS

- High-speed parallel positive edge-triggered registers with D-type flip-flops
 - CP-Y propagation delay = 8 ns typical
- Low standby power
- JEDEC FCT-compatible specs
- $I_{OL} = 24$ mA, Commercial and Military
- Extra-wide (9- and 10-bit) data paths
- Am29C900 DIP pinout option reduces lead inductance on V_{CC} and GND pins

GENERAL DESCRIPTION

The Am29C821 and Am29C823 CMOS Bus Interface Registers are designed to eliminate the extra devices required to buffer stand alone registers and to provide extra data width for wider address/data paths or buses carrying parity. The Am29C800 registers are produced with AMD's exclusive CS-11 CMOS process, and feature typical propagation delays of 8 ns, as well as an output current drive of 24 mA.

The Am29C821 is a buffered, 10-bit version of the popular '374/'534 function. The Am29C823 is a 9-bit buffered

register with Clock Enable (\overline{EN}) and Clear (\overline{CLR}) — ideal for parity bus interfacing in high-performance microprogrammed systems.

The Am29C821 and Am29C823 are available in the standard package options: DIPs, PLCCs, LCCs, SOICs, and Flatpacks. In addition, a DIP pinout option, featuring center V_{CC} and GND pins, reduces the lead inductance of the V_{CC} and GND pins. The ordering part numbers for CMOS registers with this pinout are the Am29C921 and Am29C923; their pinouts are shown later in this data sheet.

BLOCK DIAGRAMS

Am29C821

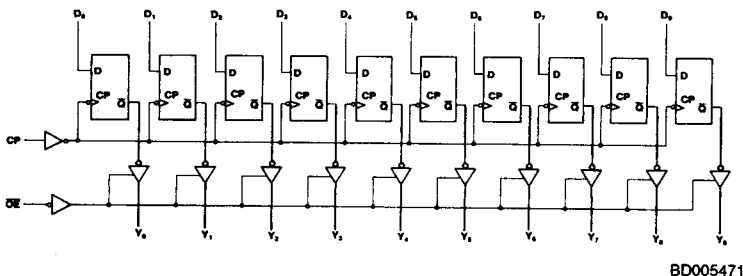

Am29C823

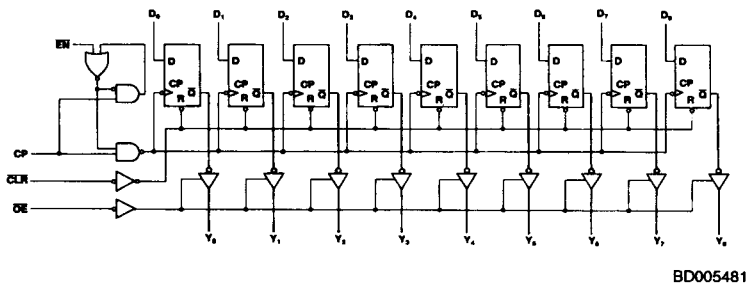

CONNECTION DIAGRAMS
Top View

Am29C821

DIPs*

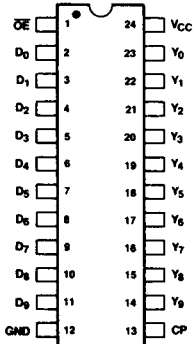

CD001360

LCC**

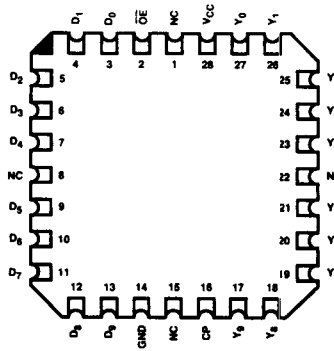

CD001370

Am29C921

DIPs

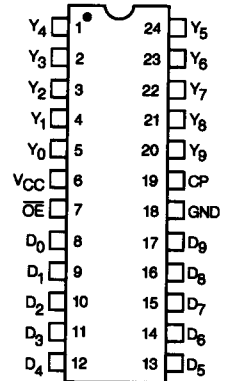

CD010716

Am29C823

DIPs*

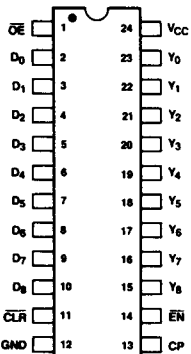

CD001220

LCC**

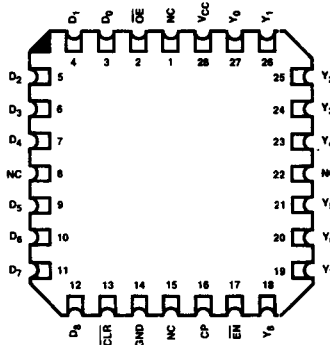

CD001230

Am29C923

DIPs

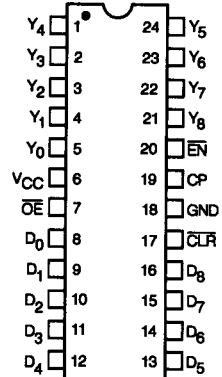

CD010717

*Also available in 24-Pin Flatpack and Small Outline packages; pinout identical to DIPs.

**Also available in 28-Pin PLCC; pinout identical to LCC.

LOGIC SYMBOLS

Am29C821

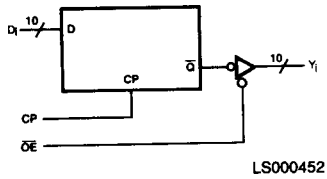

Am29C823

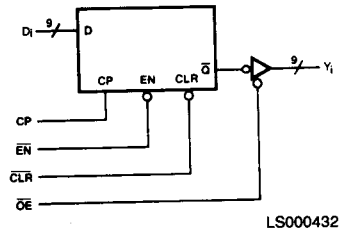

Am29C821/Am29C823
Am29C921/Am29C923

FUNCTION TABLES

Am29C821

Inputs			Internal	Outputs	Function
OE	D ₁	CP	Q ₁	Y ₁	
H	L	↑	H	Z	Hi-Z
H	H	↑	L	Z	
L	L	↑	H	L	Load
L	H	↑	L	H	

Am29C823

Inputs					Internal	Outputs	Function
OE	CLR	EN	D ₁	CP	Q ₁	Y ₁	
H	H	L	L	↑	H	Z	Hi-Z
H	H	L	H	↑	L	Z	
H	L	X	X	X	H	Z	Clear
L	L	X	X	X	H	L	
H	H	H	X	X	NC	Z	Hold
L	H	H	X	X	NC	NC	
H	H	L	L	↑	H	Z	Load
H	H	L	H	↑	L	Z	
L	H	L	L	↑	H	L	
L	H	L	H	↑	L	H	

H = HIGH
L = LOW
X = Don't Care

NC = No Change
↑ = LOW-to-HIGH Transition
Z = High Impedance

**ORDERING INFORMATION
Standard Products**

AMD products are available in several packages and operating ranges. The order number (Valid Combination) is formed by a combination of:

- a. **Device Number**
- b. **Speed Option** (if applicable)
- c. **Package Type**
- d. **Temperature Range**
- e. **Optional Processing**

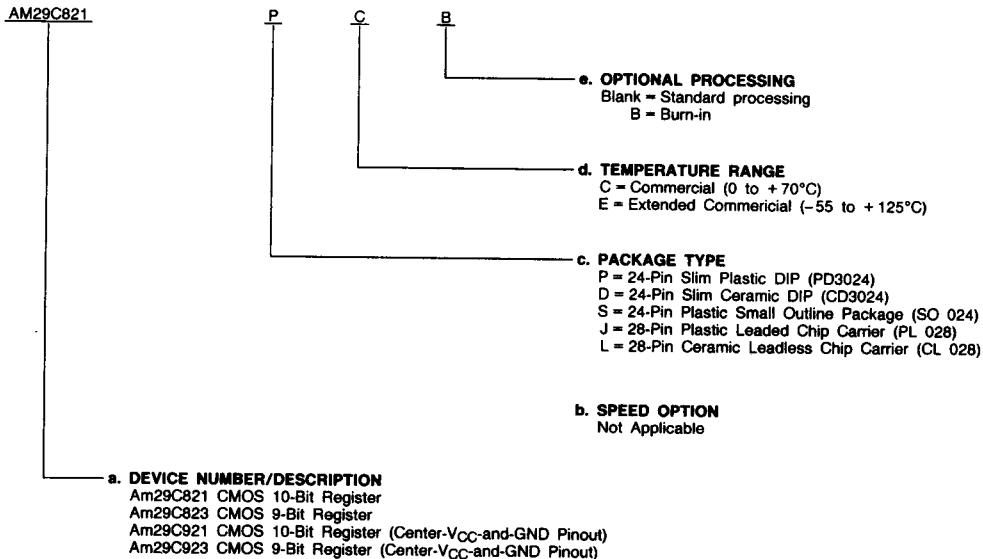

Valid Combinations	
AM29C821	PC, PCB, DC, DCB, DE, SC, JC, LC
AM29C823	
AM29C921	PC, PCB, DC, DCB, DE
AM29C923	

Valid Combinations

Valid Combinations list configurations planned to be supported in volume for this device. Consult the local AMD sales office to confirm availability of specific valid combinations, to check on newly released valid combinations, and to obtain additional data on AMD's standard military grade products.

ORDERING INFORMATION (Cont'd.)

APL Products

AMD products for Aerospace and Defense applications are available in several packages and operating ranges. APL (Approved Products List) products are fully compliant with MIL-STD-883C requirements. The order number (Valid Combination) for APL products is formed by a combination of:

- a. Device Number
- b. Speed Option (if applicable)
- c. Device Class
- d. Package Type
- e. Lead Finish

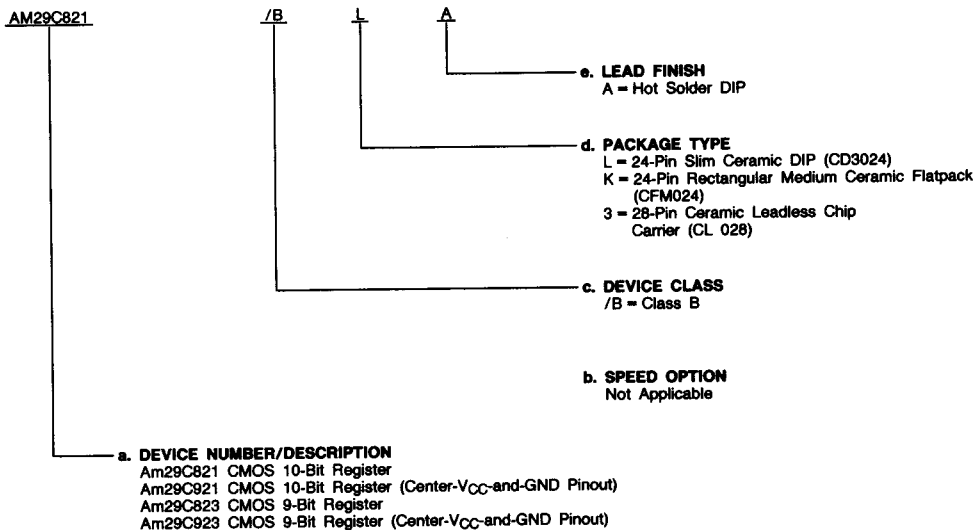

Valid Combinations	
AM29C821	/BLA, /BKA, /B3A
AM29C823	
AM29C921	/BLA
AM29C923	

Valid Combinations

Valid Combinations list configurations planned to be supported in volume for this device. Consult the local AMD sales office to confirm availability of specific valid combinations or to check for newly released valid combinations.

Group A Tests

Group A tests consist of Subgroups 1, 2, 3, 7, 8, 9, 10, 11.

PIN DESCRIPTION

Am29C821/Am29C823

D_i Data Input (Input)

D_i are the register data inputs.

CP Clock Pulse (Input, LOW-to-HIGH Transition)

Clock Pulse is the clock input for the registers. Data is entered into the registers on the LOW-to-HIGH transitions.

Y_i Data Outputs (Output)

Y_i are the three-state outputs.

OE Output Enable (Input, Active LOW)

When the OE input is HIGH, the Y_i outputs are in the high-impedance state. When OE is LOW, the register data is present at the Y_i outputs.

Am29C823 only:

EN Clock Enable (Input, Active LOW)

When EN is LOW, data on the D_i inputs are transferred to the Q_i outputs on the LOW-to-HIGH clock transition. When EN is HIGH, the Q_i outputs do not change state, regardless of the data or clock input transitions.

CLR Clear (Input, Active LOW)

When CLR is LOW, the internal register is cleared. When CLR is LOW and OE is LOW, the Q_i outputs are HIGH. When CLR is HIGH, data can be entered into the register.

Am29C821/Am29C823
Am29C921/Am29C923

ABSOLUTE MAXIMUM RATINGS

Storage Temperature	-65 to +150°C
Supply Voltage to Ground Potential	
Continuous	-0.5 V to +7.0 V
DC Output Voltage	-0.5 V to $V_{CC} + 0.5$ V
DC Input Voltage	-0.5 V to $V_{CC} + 0.5$ V
DC Output Diode Current: Into Output	+50 mA
Out of Output	-50 mA
DC Input Diode Current: Into Input	+20 mA
Out of Input	-20 mA
DC Output Current per Pin: I_{Sink}	+48 mA ($2 \times I_{OL}$)
I_{Source}	-30 mA ($2 \times I_{OH}$)
Total DC Ground Current ($n \times I_{OL} + m \times I_{CCT}$) mA (Note 1)	
Total DC V_{CC} Current ($n \times I_{OH} + m \times I_{CCT}$) mA (Note 1)	

Stresses above those listed under ABSOLUTE MAXIMUM RATINGS may cause permanent device failure. Functionality at or above these limits is not implied. Exposure to absolute maximum ratings for extended periods may affect device reliability.

OPERATING RANGES

Commercial (C) Devices	
Temperature (T_A)	0 to +70°C
Supply Voltage (V_{CC})	+4.5 V to +5.5 V
Military (M) and Extended Commercial (E) Devices	
Temperature (T_A)	-55 to +125°C
Supply Voltage (V_{CC})	+4.5 V to +5.5 V

Operating ranges define those limits between which the functionality of the device is guaranteed.

DC CHARACTERISTICS over operating range unless otherwise specified (for APL Products, Group A, Subgroups 1, 2, 3 are tested unless otherwise noted)

Parameter Symbol	Parameter Description	Test Conditions		Min.	Max.	Units
V_{OH}	Output HIGH Voltage	$V_{CC} = 4.5$ V $V_{IN} = V_{IH}$ or V_{IL}	$I_{OH} = -15$ mA	2.4		Volts
V_{OL}	Output LOW Voltage	$V_{CC} = 4.5$ V $V_{IN} = V_{IH}$ or V_{IL}	$I_{OL} = 24$ mA		0.5	Volts
V_{IH}	Input HIGH Voltage	Guaranteed Input Logical HIGH Voltage for All Inputs (Note 2)		2.0		Volts
V_{IL}	Input LOW Voltage	Guaranteed Input Logical LOW Voltage for All Inputs (Note 2)			0.8	Volts
V_i	Input Clamp Voltage	$V_{CC} = 4.5$ V, $I_{IN} = -18$ mA			-1.2	Volts
I_{IL}	Input LOW Current	$V_{CC} = 5.5$ V, $V_{IN} = GND$			-10	μ A
		$V_{CC} = 5.5$ V, $V_{IN} = 0.4$ V			-5	
I_{IH}	Input HIGH Current	$V_{CC} = 5.5$ V, $V_{IN} = 2.7$ V			5	μ A
		$V_{CC} = 5.5$ V, $V_{IN} = 5.5$ V			10	
I_{OZH}	Output Off-State Current (High Impedance)	$V_{CC} = 5.5$ V, $V_0 = 5.5$ V or 2.7 V (Note 3)			+10	μ A
I_{OZL}		$V_{CC} = 5.5$ V, $V_0 = 0.4$ V or GND (Note 3)			-10	
I_{SC}	Output Short-Circuit Current	$V_{CC} = 5.5$ V, $V_0 = 0$ V (Note 4)		-60		mA
I_{CCQ}	Static Supply Current	$V_{CC} = 5.5$ V Outputs Open	$V_{IN} = V_{CC}$ or GND	MIL	160	μ A
				COM'L	120	
I_{CCT}			$V_{IN} = 3.4$ V	Data Input	1.5	mA/Bit
		OE, CLR, CP, EN	3.0			
$I_{CCD}\dagger$	Dynamic Supply Current	$V_{CC} = 5.5$ V (Note 5)			275	μ A/MHz/Bit

- Notes: 1. n = number of outputs, m = number of inputs.
 2. Input thresholds are tested in combination with other DC parameters or by correlation.
 3. Off-state currents are only tested at worst-case conditions of $V_{OUT} = 5.5$ V or 0.0 V.
 4. Not more than one output shorted at a time. Duration should not exceed 100 milliseconds.
 5. Measured at a frequency ≤ 10 MHz with 50% duty cycle.

† Not included in Group A tests.

SWITCHING CHARACTERISTICS over operating range unless otherwise specified (for APL Products, Group A, Subgroups 9, 10, 11 are tested unless otherwise noted)

Parameter Symbol	Parameter Description	Test Conditions*	COMMERCIAL		MILITARY		Units	
			Min.	Max.	Min.	Max.		
t _{PLH}	Propagation Delay Clock to Y _i (OE = LOW)	C _L = 50 pF R ₁ = 500 Ω R ₂ = 500 Ω		12		14	ns	
t _{PHL}				12		14	ns	
t _S	Data to CP Setup Time		4		6		ns	
t _H	Data to CP Hold Time		2		3		ns	
t _S	Enable (EN $\overline{\text{L}}$) to CP Setup Time		4		6		ns	
t _S	Enable (EN $\overline{\text{L}}$) to CP Setup Time		4		6		ns	
t _H	Enable (EN) Hold Time		2		3		ns	
t _{PHL}	Propagation Delay, Clear to Y _i			13		15	ns	
t _{REC}	Clear (CLR $\overline{\text{L}}$) to CP Setup Time		4		6		ns	
t _{PWH}	Clock Pulse Width		HIGH	7		11		ns
t _{PWL}			LOW	7		11		ns
t _{PWL}	Clear Pulse Width		7		11		ns	
t _{ZH}	Output Enable Time OE $\overline{\text{L}}$ to Y _i			12		14		ns
t _{ZL}				12		14		ns
t _{HZ}	Output Disable Time OE $\overline{\text{L}}$ to Y _i			12		14		ns
t _{LZ}				12		14		ns

*See Test Circuit and Waveforms.

PACKAGE OUTLINES*

T-90-20

PD3024

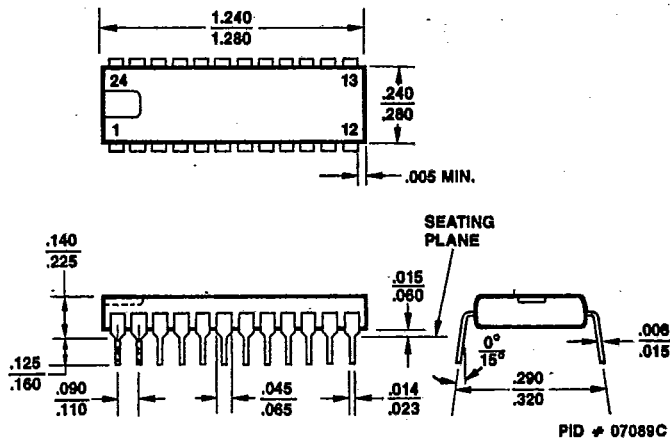

CD3024

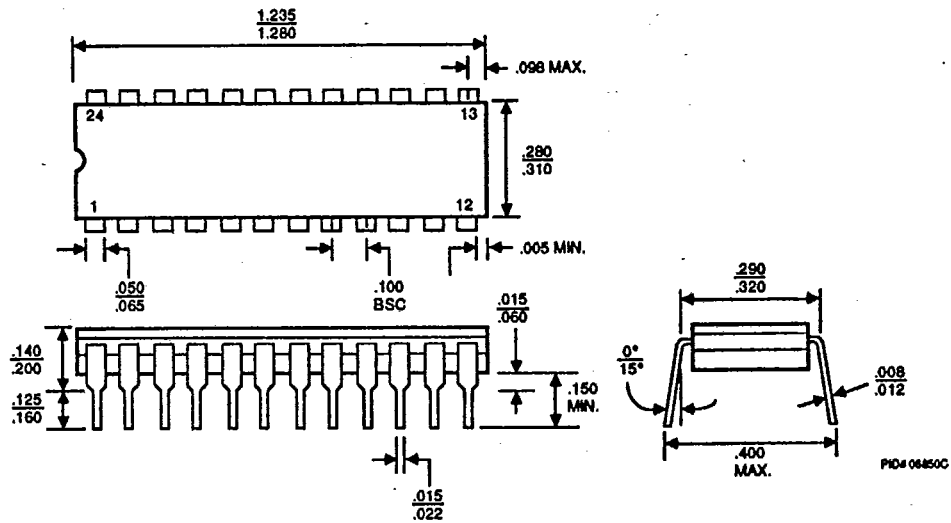

*For reference only.

PACKAGE OUTLINES (Cont'd.)

T-90-20

SO 024

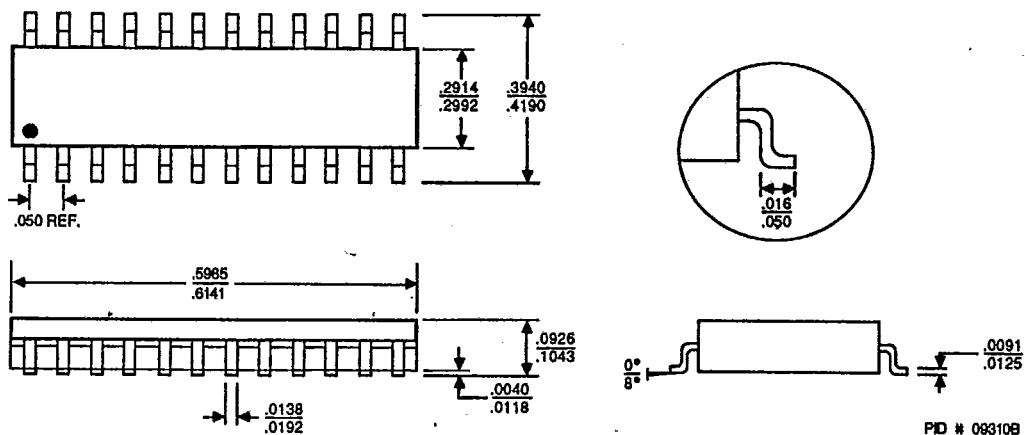

CFM024

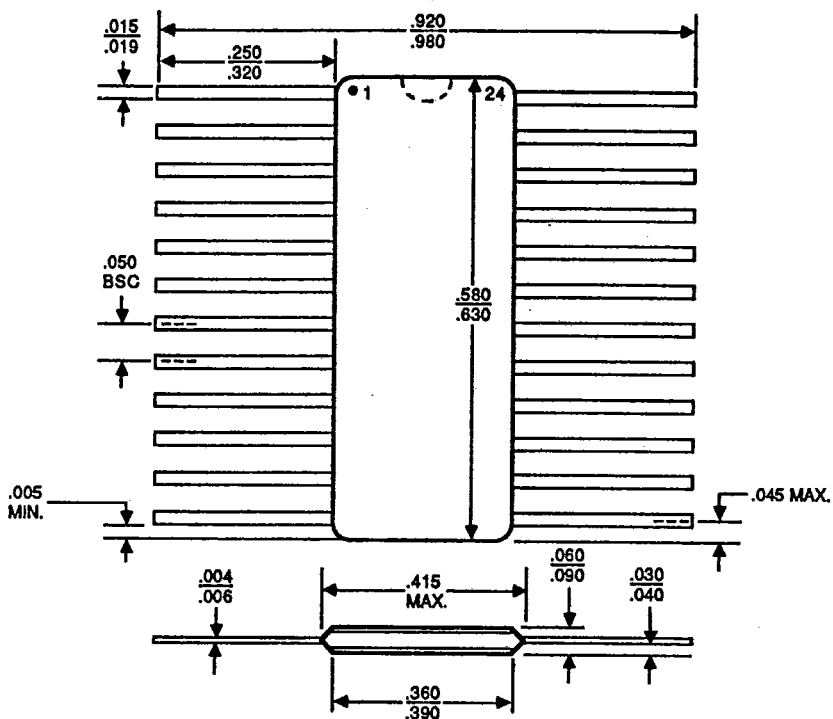

PACKAGE OUTLINES (Cont'd.)

T-90-20

PL 028

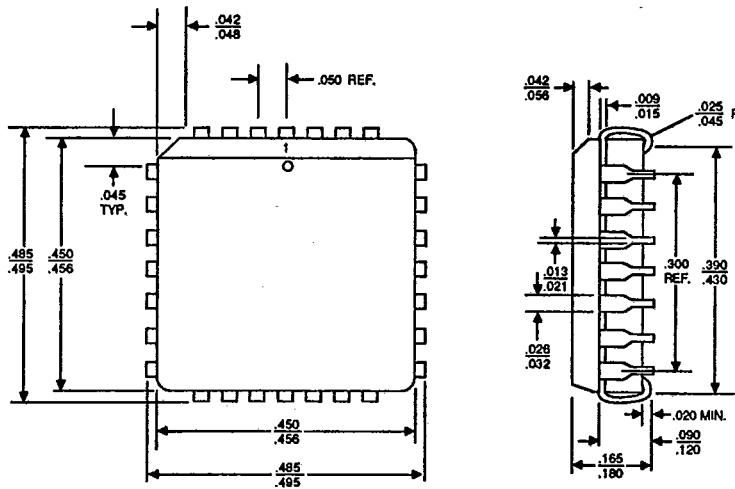

PID # 06751E

CL 028

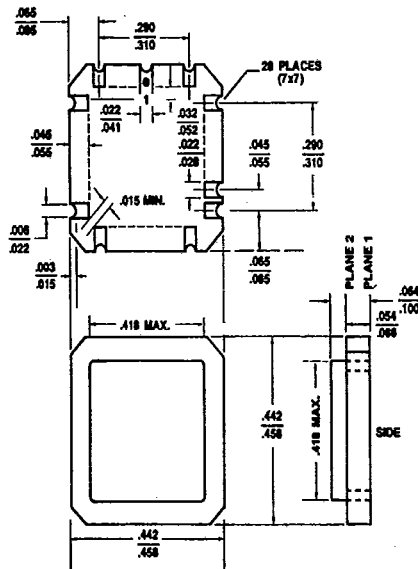

PID # 06595D

Advanced Micro Devices reserves the right to make changes in its product without notice in order to improve design or performance characteristics. The performance characteristics listed in this document are guaranteed by specific tests, correlated testing, guard banding, design and other practices common to the industry. For specific testing details, contact your local AMD sales representative. The company assumes no responsibility for the use of any circuits described herein.



ADVANCED MICRO DEVICES 901 Thompson Pl., P.O. Box 3453, Sunnyvale, CA 94088, USA
 TEL: (408) 732-2400 • TWX: 910-339-9280 • TELEX: 34-6306 • TOLL FREE: (800) 638-8450

© 1988 Advanced Micro Devices, Inc.
 Printed in U.S.A. AIS-WCP-20M-01/88-0