

CD4028B Types

CMOS BCD-to-Decimal Decoder

High-Voltage Types (20-Volt Rating)

The RCA-CD4028B types are BCD-to-decimal or binary-to-octal decoders consisting of buffering on all 4 inputs, decoding logic gates, and 10 output buffers. A BCD code applied to the four inputs, A to D, results in a high level at the selected one of 10 decimal decoded outputs. Similarly, a 3-bit binary code applied to inputs A through C is decoded in octal code at output 0 to 7 if D = "0". High drive capability is provided at all outputs to enhance dc and dynamic performance in high fan-out applications.

The CD4028B-Series types are supplied in 16-lead hermetic dual-in-line ceramic packages (D and F suffixes), 16-lead dual-in-line plastic packages (E suffix), 16-lead ceramic flat packages (K suffix), and in chip form (H suffix).

Features:

- BCD-to-decimal decoding or binary-to-octal decoding
- High decoded output drive capability
- "Positive logic" inputs and outputs. decoded outputs go high on selection
- Medium-speed operation.
- $t_{PHL}, t_{PLH} = 80 \text{ ns (typ.) @ } V_{DD} = 10 \text{ V}$
- Standardized, symmetrical output characteristics
- 100% tested for quiescent current at 20 V
- Maximum input current of 1 μA at 18 V over full package-temperature range; 100 nA at 18 V and 25°C
- Noise margin (over full package-temperature range):
 - 1 V at $V_{DD} = 5 \text{ V}$
 - 2 V at $V_{DD} = 10 \text{ V}$
 - 2.5 V at $V_{DD} = 15 \text{ V}$
- 5-V, 10-V, and 15-V parametric ratings
- Meets all requirements of JEDEC Tentative Standard No. 13A, "Standard Specifications for Description of 'B' Series CMOS Devices"

Applications:

- Code conversion
- Indicator-tube decoder
- Address decoding—memory selection control

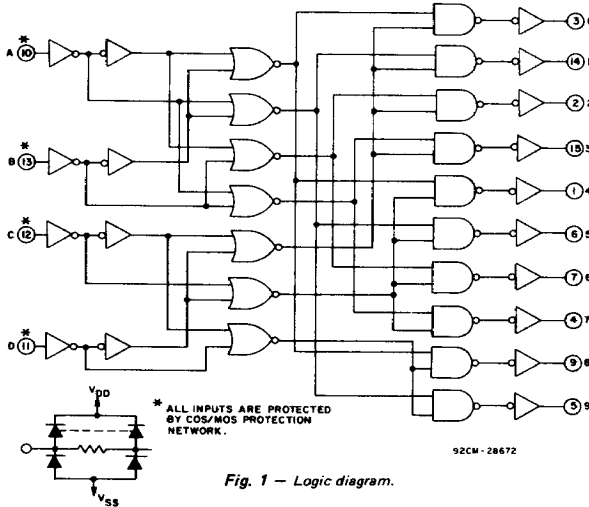
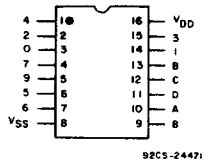
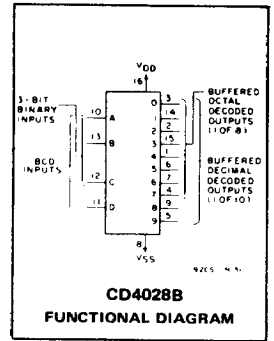

MAXIMUM RATINGS, Absolute-Maximum Values:

DC SUPPLY-VOLTAGE RANGE, (V_{DD}) (Voltages referenced to V_{SS} Terminal)	-0.5 to +20 V
INPUT VOLTAGE RANGE, ALL INPUTS	-0.5 to $V_{DD} + 0.5 \text{ V}$
DC INPUT CURRENT, ANY ONE INPUT	$\pm 10 \text{ mA}$
POWER DISSIPATION PER PACKAGE (P_D):	
For $T_A = -40$ to $+60^\circ\text{C}$ (PACKAGE TYPE E)	500 mW
For $T_A = +60$ to $+85^\circ\text{C}$ (PACKAGE TYPE E)	Derate Linearly at 12 mW/ $^\circ\text{C}$ to 200 mW
For $T_A = -55$ to $+100^\circ\text{C}$ (PACKAGE TYPES D, F, K)	500 mW
For $T_A = +100$ to $+125^\circ\text{C}$ (PACKAGE TYPES D, F, K)	Derate Linearly at 12 mW/ $^\circ\text{C}$ to 200 mW
DEVICE DISSIPATION PER OUTPUT TRANSISTOR	
For $T_A = \text{FULL PACKAGE-TEMPERATURE RANGE (All Package Types)}$	100 mW
OPERATING-TEMPERATURE RANGE (T_A):	
PACKAGE TYPES D, F, K, H	-55 to $+125^\circ\text{C}$
PACKAGE TYPE E	-40 to $+85^\circ\text{C}$
STORAGE TEMPERATURE RANGE (T_{stg})	-85 to $+150^\circ\text{C}$
LEAD TEMPERATURE (DURING SOLDERING):	
At distance 1/16 \pm 1/32 inch (1.59 \pm 0.79 mm) from case for 10 s max.	$+265^\circ\text{C}$

TABLE I - TRUTH TABLE

D	C	B	A	0	1	2	3	4	5	6	7	8	9
0	0	0	0	1	0	0	0	0	0	0	0	0	0
0	0	0	1	0	1	0	0	0	0	0	0	0	0
0	0	1	0	0	0	1	0	0	0	0	0	0	0
0	0	1	1	0	0	0	1	0	0	0	0	0	0
0	1	0	0	0	0	0	0	1	0	0	0	0	0
0	1	0	1	0	0	0	0	0	1	0	0	0	0
0	1	1	0	0	0	0	0	0	0	1	0	0	0
0	1	1	1	0	0	0	0	0	0	0	1	0	0
1	0	0	0	0	0	0	0	0	0	0	0	1	0
1	0	0	1	0	0	0	0	0	0	0	0	0	1
1	0	1	0	0	0	0	0	0	0	0	0	0	0
1	0	1	1	0	0	0	0	0	0	0	0	0	0
1	1	0	0	0	0	0	0	0	0	0	0	0	0
1	1	0	1	0	0	0	0	0	0	0	0	0	0
1	1	1	0	0	0	0	0	0	0	0	0	0	0
1	1	1	1	0	0	0	0	0	0	0	0	0	0

I = HIGH LEVEL 0 = LOW LEVEL

CD4028B Types

RECOMMENDED OPERATING CONDITIONS

For maximum reliability, nominal operating conditions should be selected so that operation is always within the following ranges:

CHARACTERISTIC	LIMITS		UNITS
	MIN.	MAX.	
Supply Voltage Range (For T_A = Full Package Temperature Range)	3	18	V

STATIC ELECTRICAL CHARACTERISTICS

CHARACTERISTIC	CONDITIONS			LIMITS AT INDICATED TEMPERATURES (°C)							UNITS
	V_O (V)	V_{IN} (V)	V_{DD} (V)	-55				+25			
				-55	-40	+85	+125	Min.	Typ.	Max.	
Quiescent Device Current, I_{DD} Max.	-	0,5	5	5	5	150	150	-	0.04	5	μA
	-	0,10	10	10	10	300	300	-	0.04	10	
	-	0,15	15	20	20	600	600	-	0.04	20	
	-	0,20	20	100	100	3000	3000	-	0.08	100	
Output Low (Sink) Current I_{OL} Min.	0,4	0,5	5	0.64	0.61	0.42	0.36	0.51	1	-	mA
	0,5	0,10	10	1.6	1.5	1.1	0.9	1.3	2.6	-	
	1,5	0,15	15	4.2	4	2.8	2.4	3.4	6.8	-	
Output High (Source) Current, I_{OH} Min.	4.6	0,5	5	-0.64	-0.61	-0.42	-0.36	-0.51	1	-	mA
	2.5	0,5	5	-2	-1.8	-1.3	-1.15	-1.6	-3.2	-	
	9.5	0,10	10	-1.6	-1.5	-1.1	-0.9	-1.3	-2.6	-	
	13.5	0,15	15	-4.2	-4	-2.8	-2.4	-3.4	-6.8	-	
Output Voltage: Low-Level, V_{OL} Max.	-	0,5	5			0.05			0	0.05	V
	-	0,10	10			0.05			0	0.05	
	-	0,15	15			0.05			0	0.05	
Output Voltage: High-Level, V_{OH} Min.	-	0,5	5			4.95		4.95	5	-	V
	-	0,10	10			9.95		9.95	10	-	
	-	0,15	15			14.95		14.95	15	-	
Input Low Voltage, V_{IL} Max.	0.5, 4.5	-	5			1.5				1.5	V
	1, 9	-	10			3				3	
	1.5, 13.5	-	15			4				4	
Input High Voltage, V_{IH} Min.	0.5, 4.5	-	5			3.5		3.5			V
	1, 9	-	10			7		7			
	1.5, 13.5	-	15			11		11			
Input Current I_{IN} Max.	-	0,18	18	± 0.1	± 0.1	± 1	± 1	-	$\pm 10^{-5}$	± 0.1	μA

DYNAMIC ELECTRICAL CHARACTERISTICS AT $T_A = 25^\circ C$, $C_L = 50$ pF,

Input $t_r, t_f = 20$ ns, $R_L = 200$ k Ω

CHARACTERISTIC	TEST CONDITIONS	LIMITS		UNITS
	V_{DD} (V)	Typ.	Max.	
Propagation Delay Time: t_{PHL}, t_{PLH}	5	175	350	ns
	10	80	160	
	15	60	120	
Transition Time t_{THL}, t_{TLH}	5	100	200	ns
	10	50	100	
	15	40	80	
Input Capacitance, C_{IN}	-	5	7.5	pF

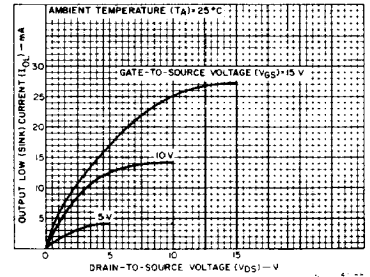

Fig. 2 — Typical output low (sink) current characteristics.

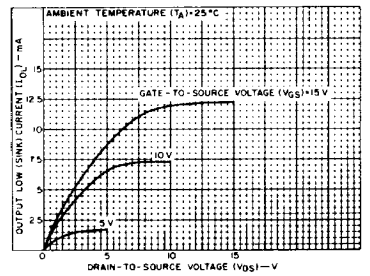

Fig. 3 — Minimum output low (sink) current characteristics.

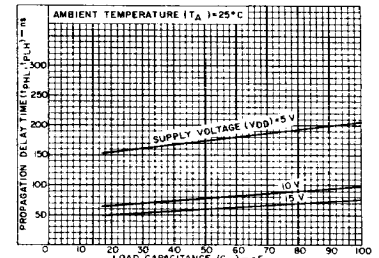

Fig. 4 — Typical propagation delay time as a function of load capacitance.

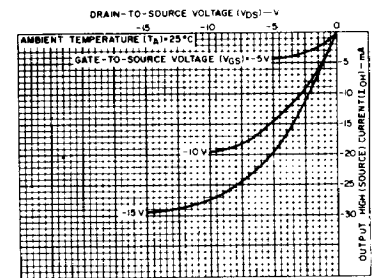

Fig. 5 — Typical output high (source) current characteristics.

CD4028B Types

TABLE II — CODE CONVERSION CHART

INPUTS				INPUT CODES					OUTPUT NUMBER																
				Hexa-Decimal		Decimal																			
D	C	B	A	4-BIT BINARY	4-BIT GRAY	EXCESS-3	EXCESS-3 GRAY	AIKEN	4-2-2-1	0	1	2	3	4	5	6	7	8	9	10	11	12	13	14	15
0	0	0	0	0	0			0	0	1	0	0	0	0	0	0	0	0	0	0	0	0	0	0	0
0	0	0	1	1	1			1	1	0	1	0	0	0	0	0	0	0	0	0	0	0	0	0	0
0	0	1	0	2	3			0	2	0	0	1	0	0	0	0	0	0	0	0	0	0	0	0	0
0	0	1	1	3	2	0	3	3	3	0	0	0	1	0	0	0	0	0	0	0	0	0	0	0	0
0	1	0	0	4	7	1	4	4	4	0	0	0	0	1	0	0	0	0	0	0	0	0	0	0	0
0	1	0	1	5	6	2			3	0	0	0	0	0	1	0	0	0	0	0	0	0	0	0	0
0	1	1	0	6	4	3	1	4	4	0	0	0	0	0	1	0	0	0	0	0	0	0	0	0	0
0	1	1	1	7	5	4	2		10	0	0	0	0	0	0	1	0	0	0	0	0	0	0	0	0
1	0	0	0	8	15	5				0	0	0	0	0	0	0	1	0	0	0	0	0	0	0	0
1	0	0	1	9	14	6			5	0	0	0	0	0	0	0	0	1	0	0	0	0	0	0	0
1	0	1	0	10	12	7	9	6		0	0	0	0	0	0	0	0	0	1	0	0	0	0	0	0
1	0	1	1	11	13	8		5		0	0	0	0	0	0	0	0	0	0	1	0	0	0	0	0
1	1	0	0	12	8	9	5	6		0	0	0	0	0	0	0	0	0	0	0	1	0	0	0	0
1	1	0	1	13	9		6	7	7	0	0	0	0	0	0	0	0	0	0	0	0	1	0	0	0
1	1	1	0	14	11	8	8	8		0	0	0	0	0	0	0	0	0	0	0	0	0	0	1	0
1	1	1	1	15	10	7	9	9		0	0	0	0	0	0	0	0	0	0	0	0	0	0	0	1

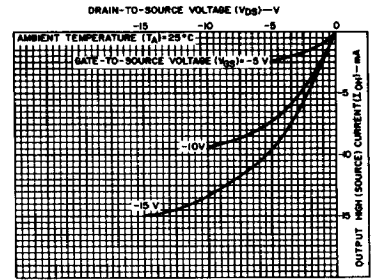

Fig. 6 — Minimum output high (source) current characteristics.

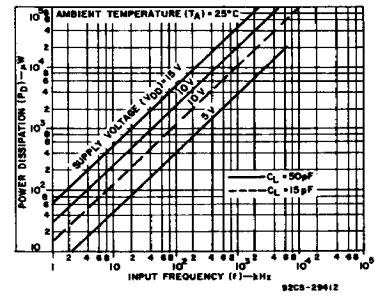

Fig. 7 — Typical dynamic power dissipation as a function of input frequency.

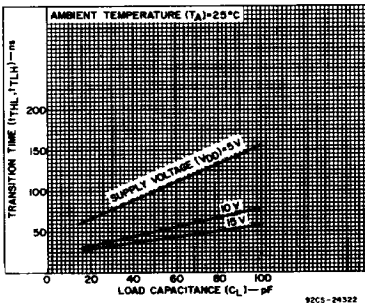

Fig. 8 — Typical transition time as a function of load capacitance.

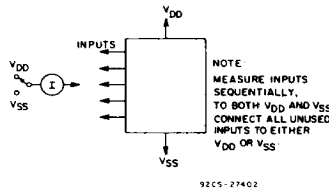

Fig. 9 — Input current test circuit.

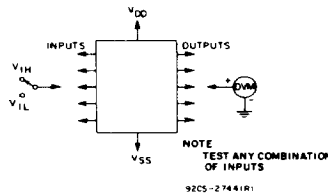

Fig. 11 — Input voltage test circuit.

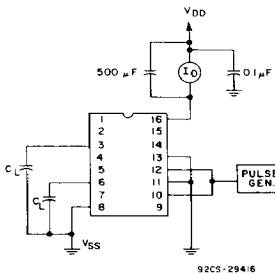

Fig. 10 — Dynamic power dissipation test circuit.

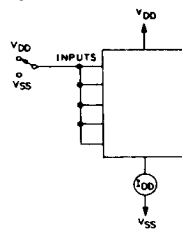

Fig. 12 — Quiescent device current test circuit.

TYPICAL APPLICATIONS

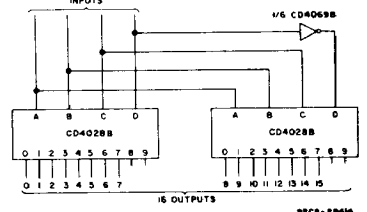
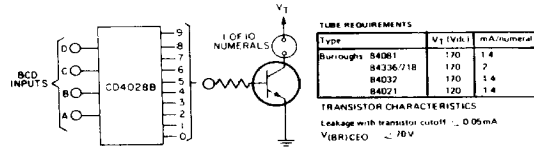

Fig. 13 — Code conversion circuit.

The circuit shown in Fig.13 converts any 4-bit code to a decimal or hexadecimal code. Table 2 shows a number of codes and the decimal or hexadecimal number in these codes which must be applied to the input terminals of the CD4028B to select a particular output. For example: in order to get a high on output No. 8 the input must be either an 8 expressed in 4-Bit Binary code, a 15 expressed in 4-Bit Gray code, or a 5 expressed in Excess-3 code.



▲(Trademark) Burroughs Corp.

Fig. 14 — Neon readout (Nixie Tube[▲]) display application.

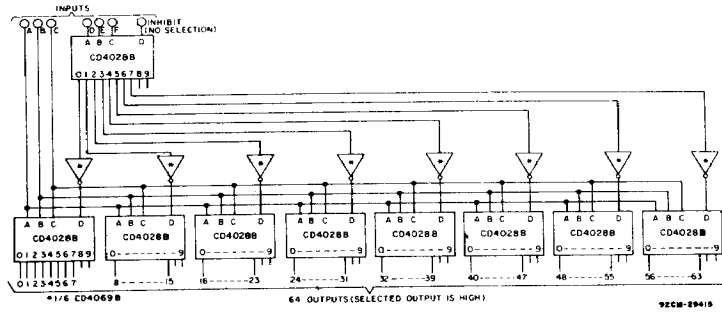
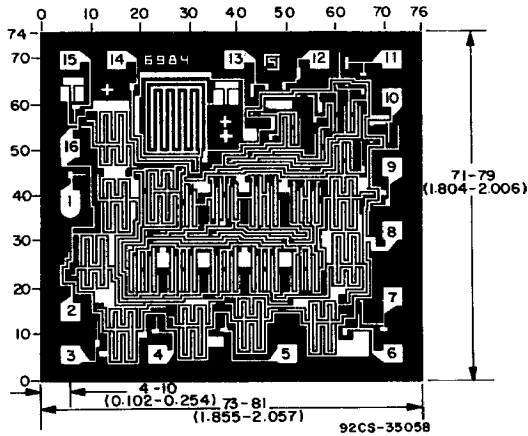

Fig. 15 — 6-bit binary to 1-of-64 address decoder.



CD4028BH
 DIMENSIONS AND PAD LAYOUT

Dimensions in parentheses are in millimeters and are derived from the basic inch dimensions as indicated. Grid graduations are in mils (10^{-3} inch).

The photographs and dimensions of each CMOS chip represent a chip when it is part of the wafer. When the wafer is separated into individual chips, the angle of cleavage may vary with respect to the chip face for different chips. The actual dimensions of the isolated chip, therefore, may differ slightly from the nominal dimensions shown. The user should consider a tolerance of -3 mils to $+16$ mils applicable to the nominal dimensions shown.